

**Bicycle Advisory Committee**

**CORRESPONDENCE**

**Part 1**

**July 16, 2015**

## McKenna, Nancy

---

**From:** Daphne Keller <daphnekeller@gmail.com>  
**Sent:** Monday, July 06, 2015 6:48 AM  
**To:** Jim Greer  
**Cc:** Board (@caltrain.com); cacsecretary (@caltrain.com); Caltrain, Bac (@caltrain.com); janice@sfbike.org; bikesonboard@sfbike.org  
**Subject:** Re: more bike space on board caltrain

I'll add my voice to this! I am the aforementioned wife, and I am anticipating with dismay driving to and from Stanford frequently in the fall. If Caltrain commuting with a bike were more feasible, I would be much, much more likely to use Caltrain for this commute.

Thanks,  
Daphne

On Mon, Jul 6, 2015 at 3:45 PM, Jim Greer <[jimgreer@gmail.com](mailto:jimgreer@gmail.com)> wrote:  
I have lived and biked in San Francisco since 1998. I live in Noe Valley, and my work frequently takes me to the Peninsula. My wife will begin commuting to Stanford in the fall.

Having more space for bikes on Caltrain is critical. Getting to Caltrain from Noe Valley is too slow on public transportation to make this a realistic option. And once you get to the peninsula, your public transit options are even more limited.

While bike lockers and bike share are important as well, they aren't great options for people who need a bike on both ends of the commute at this time.

Thanks,  
Jim Greer  
3855 25th St, San Francisco, CA 94114  
Co-founder, Kongregate and CounterPAC

## McKenna, Nancy

---

**From:** Jim Greer <jimgreer@gmail.com>  
**Sent:** Monday, July 06, 2015 6:46 AM  
**To:** Board (@caltrain.com); cacsecretary (@caltrain.com); Caltrain, Bac (@caltrain.com)  
**Cc:** janice@sfbike.org; bikesonboard@sfbike.org  
**Subject:** more bike space on board caltrain

I have lived and biked in San Francisco since 1998. I live in Noe Valley, and my work frequently takes me to the Peninsula. My wife will begin commuting to Stanford in the fall.

Having more space for bikes on Caltrain is critical. Getting to Caltrain from Noe Valley is too slow on public transportation to make this a realistic option. And once you get to the peninsula, your public transit options are even more limited.

While bike lockers and bike share are important as well, they aren't great options for people who need a bike on both ends of the commute at this time.

Thanks,  
Jim Greer  
3855 25th St, San Francisco, CA 94114  
Co-founder, Kongregate and CounterPAC

## McKenna, Nancy

---

**From:** Terrance Amsler <amslersf@gmail.com>  
**Sent:** Sunday, July 05, 2015 8:26 PM  
**To:** Board (@caltrain.com); cacsecretary (@caltrain.com); Caltrain, Bac (@caltrain.com)  
**Cc:** janice@sfbike.org; bikesonboard@sfbike.org  
**Subject:** I Support More Bike Space On Board and More Bike Parking for Caltrain

Hello,

My family does not have a car and we often have to juggle transportation strategies to visit our children's cousins and grandparents in San Mateo. The favorite way to go for our two children is, by far, biking to Caltrain, taking the train then biking over to their grandma's house. However, worries about being bumped keep us from ever going on a weekday. We'll zip car down instead. Getting bumped is inconvenient for everyone, but when traveling with two children, you don't want to even take the risk. Please vote for a system that can take the guess work out of biking on the train. Families deserve it. Thanks, Terrance Amsler

---

Terrance Amsler  
471 14th Street  
San Francisco CA 94103

415-861-4648

## McKenna, Nancy

---

**From:** Bianca Morales <[bianca.scura@gmail.com](mailto:bianca.scura@gmail.com)>  
**Sent:** Friday, July 03, 2015 3:49 PM  
**To:** Board (@caltrain.com)  
**Cc:** Bikes on Board; Nabong, Sarah; Murphy, Seamus; cacsecretary (@caltrain.com); Caltrain, Bac (@caltrain.com)  
**Subject:** Re: Increase bike capacity on electrified trains!

Dear Caltrain,

Thank you for demonstrating your support for a more sustainable, bike- and earth-friendly future. While there is more to be done, I (and many other bike passengers) very much appreciate this concrete step in the right direction.

As was stated in yesterday's meeting, key to making a good decision is making an informed decision. It is important to first identify the needs of the bike passenger community and the nature of their commutes to determine the extent to which wayside bike storage and services like bike-share would actually reduce the number of bikes on board. I think you will find that making good use of these services requires a very specific commute profile that is incompatible with many if not most bike passengers, who rely on their bikes for both ends of their commute. Ultimately, the right mix of options, with increased bike capacity as a central component, will be necessary to meet the growing demand over the next 5 years.

Again, thank you for your good work and for moving forward in a positive and constructive manner. I look forward to continuing the dialogue.

Best regards,  
Bianca Morales

On Wed, Jun 24, 2015 at 8:05 PM, Bianca Morales <[bianca.scura@gmail.com](mailto:bianca.scura@gmail.com)> wrote:  
Dear Caltrain,

If I couldn't bike to work, I couldn't work at my dream job at the Exploratorium. The commute would simply be unsustainable, nearing 5 hours a day. That said, I have had to consistently shift my work schedule earlier and earlier to have a chance of reliably getting on the train and getting to work due to overcrowding. I now find myself going to bed when the sun is still out to wake up at 5:00a just to catch a train I know I will get on. When I found out the new electrified trains won't increase bike capacity, it is an understatement to say I was disappointed.

I understand that bike passengers are not the only passengers on the train, but already today in 2015, bike overcrowding during rush hour is a serious issue obstructing and preventing people from making the health- and earth-conscious decision to bike to work.

I implore you to please reconsider this decision and increase bike capacity by 20%. Because to do nothing in a time of rapid bike passenger growth would be very harmful to the current and future biking community. It would have larger effects on bike-share programs and bike-friendly streets and neighborhoods, providing people with another excuse to continue driving their cars or worse, to not go out into the community at all.

Sincerely,

## McKenna, Nancy

---

**From:** George Halet <georgehalet@gmail.com>  
**Sent:** Thursday, July 02, 2015 7:18 PM  
**To:** Board (@caltrain.com); cacsecretary (@caltrain.com); Caltrain, Bac (@caltrain.com)  
**Subject:** Caltrain Rider Advocate for Policies that Encourage Bicycle Riders

Dear Caltrain Board,

As a long-time bicycle-riding Caltrain rider, this service has made an immense and positive impact on my quality of life and helped avoid 1000s of car trips.

I encourage you to seriously consider the SF Bicycle Coalition proposals to

- Provide bike capacity for at least 16 percent of Caltrain passengers
- Support the transit agency making it an official goal that at least 20 percent of Caltrain passengers will access the system by bike by 2020

Thank you for the existing bike-friendly service and your continued commitment to this segment of your ridership, including the three million dollar investment in secure bike parking.

I traveled a few times to Switzerland on business and it is awe inspiring to see the hundreds of bicycles parked outside of every train station. Your continued efforts in this direction will contribute to our becoming a more civilized and healthy society.

Sincerely,

George Halet  
San Mateo

## McKenna, Nancy

---

**From:** De La Torre, Andria  
**Sent:** Thursday, July 02, 2015 5:35 PM  
**To:** 'michael.pes@icloud.com'  
**Cc:** 'bikesonboard@sfbike.org'; 'janice@sfbike.org'; Board (@caltrain.com); Bartholomew, Tasha; cacsecretary (@caltrain.com); Caltrain, Bac (@caltrain.com)  
**Subject:** Overzealous controllers bumped bikes on an empty train today

Good afternoon Michael. Your message to the Caltrain Board of Directors, Caltrain Citizens Advisory Committee and Bicycle Advisory Committee was referred to me for response. The groups will receive a copy of our correspondence.

Thank you for letting us know about your observations of Train 288 on Caltrain yesterday. We regret to hear that you observed more bike space within the bike racks than were allowed to board. We have shared this report with our Operations staff to review the capacity limits with the conductors.

We expect our Caltrain conductors to assist with crowd control as customers are moving in and out of the train cars. On occasion the bicycle racks may get out of balance, however, in the bike cars, each rack can safely accommodate up to four bikes. Our conductors are responsible for only allowing a safe number of customers with bikes board the train as the total count cannot exceed 48 on Bombardier equipment and 80 on our Gallery equipment.

Again, we apologize for the oversight you observed. We value your input and thank you for sharing your feedback.

Kind Regards,

Andria

**Andria De La Torre**  
SamTrans | Caltrain | TA  
Customer Service Department  
1250 San Carlos Ave.  
San Carlos, CA 94070-1306  
1-800-660-4287  
[www.smctd.com](http://www.smctd.com)

Sent: Wednesday, July 01, 2015 7:08 PM  
To: Nabong, Sarah  
Cc: [bikesonboard@sfbike.org](mailto:bikesonboard@sfbike.org); [janice@sfbike.org](mailto:janice@sfbike.org); Board (@caltrain.com); Bartholomew, Tasha; cacsecretary (@caltrain.com); Caltrain, Bac (@caltrain.com)  
Subject: Overzealous controllers bumped bikes on an empty train today

Dear Caltrain Board members,

I was admitted on Caltrain 288 in San Francisco 4th and King with a folding bike while 10 regular bikes were bumped at the San station at 6:50pm. This was the last chance for them to use a limited express. Once on board the front bike car, I noticed that there was on average only 3 bikes per rack and counted room for 6 more bikes that could have been admitted on board. The back car did not seem overloaded either. Have we reduced the amount of bikes per train?

Thanks

## McKenna, Nancy

---

**From:** Angela Legg <alegg@stanford.edu>  
**Sent:** Thursday, July 02, 2015 1:32 PM  
**To:** Board (@caltrain.com); cacsecretary (@caltrain.com); Caltrain, Bac (@caltrain.com)  
**Cc:** janice@sfbike.org; bikesonboard@sfbike.org  
**Subject:** I Support More Bike Space On Board and More Bike Parking for Caltrain

Dear Board members,

I would like to ask that you please strongly consider a design for new train cars that provides bike capacity for at least 16 percent of Caltrain passengers and that you support the transit agency in making it an official goal that at least 20 percent of Caltrain passengers will access the system by bike by 2020. I would also like to express my gratitude to the Caltrain staff for recommending a significant \$3 million investment in secure bike parking and I would encourage the Board to approve this recommendation.

Thank you so much for your consideration.

Best,

Angela Legg



## McKenna, Nancy

---

**From:** David Groves <4davidgroves@gmail.com>  
**Sent:** Thursday, July 02, 2015 12:55 PM  
**To:** Board (@caltrain.com); cacsecretary (@caltrain.com); Caltrain, Bac (@caltrain.com)  
**Cc:** janice@sfbike.org; Bikes on Board; ddavid.groves@yahoo.com  
**Subject:** I Support More Bike Space On Board and More Bike Parking for Caltrain

Thursday July 2 2014

Caltrains Please preserve the current bike capacity and I strongly recommend that you plan to increase the capacity of future (EMU) electric train cars, to give cyclist like me, who happen to be disabled an alternative to driving his vehicle to the Menlo Park and Palo Alto V.A.. I look forward to cycling up from the California Street Station to the Palo Alto VA via Hanover Street on the Bol Park Pedestrian Parkway because it gets me to my appointments and I do not have to worry about taking another parking space, and when I arrive I am worry free because I don't have to hassle to find a parking space, and i get the added benefit of getting exercise and not added to the commute on the freeway, which adds up to a lot of wasted non productive time.

I buy a monthly two zone pass to get to my appointments and i recognize that Caltrain should preserve the current bike capacity of the current rolling stock, ("it works") but for our future cyclist should have reliable facilities during morning and afternoon commute.

because i know how it feels to have ticket in hand, and the conductor says no more bike, Please No More Bumps!

David Groves  
501 tilton avenue  
San Mateo, CA 94401

## McKenna, Nancy

---

**From:** Marta Hanson <marta.hanson@gmail.com>  
**Sent:** Thursday, July 02, 2015 11:44 AM  
**To:** Board (@caltrain.com); cacsecretary (@caltrain.com); Caltrain, Bac (@caltrain.com)  
**Cc:** Janice Li; bikesonboard@sfbike.org  
**Subject:** I Support More Bike Space On Board and More Bike Parking for Caltrain

A HUGE thanks to conductors who are already great about ensuring that bikers get priority in the bike car (as other passengers get priority in the rest of the train...)!

The

Please & thank you!

--

Marta Hanson  
[marta.hanson@gmail.com](mailto:marta.hanson@gmail.com)  
[503.961.4420](tel:503.961.4420)

*Be the change you wish to see in the world.*

## McKenna, Nancy

---

**From:** Ron Yamamoto <ron@medterials.com>  
**Sent:** Thursday, July 02, 2015 11:05 AM  
**To:** Board (@caltrain.com); cacsecretary (@caltrain.com); Caltrain, Bac (@caltrain.com)  
**Cc:** janice@sfbike.org; bikesonboard@sfbike.org  
**Subject:** I Support More Bike Space On Board and More Bike Parking for Caltrain

Dear Caltrain Board,

I just wanted to let you know I have been commuting from San Francisco to the peninsula for approximately 20 years. I used to bike commute using CalTrain weekly but no longer due to lack of space. The problem is not usually leaving from San Francisco, but the return trip where I have to wait several trains to find one with space. In addition, there is usually lack of order for those waiting the longest for a spot, leading to aggressive behavior by a few. I have seen many pushed out although they have been waiting longer than others.

I still bike commute, but when I work in Europe where the trains have dedicated bike space and an orderly arrangement for the commuters. No wonder people of all types including retirees and young children use bike trains in Europe.

Ron Yamamoto  
San Francisco Resident

## McKenna, Nancy

---

**From:** Betsy Megas <dvortygirl@gmail.com>  
**Sent:** Thursday, July 02, 2015 9:54 AM  
**To:** Board (@caltrain.com); cacsecretary (@caltrain.com); Caltrain, Bac (@caltrain.com)  
**Subject:** In favor of bikes on Caltrain

To Caltrain:

### **Please be generous when anticipating bike capacity for Caltrain's future.**

I can't attend the meeting today, and I'd like to submit a comment about bike capacity for Caltrain's future. As I'm sure you are already aware, the ability to bring bikes on Caltrain is a tremendous benefit. Bikes help to shorten that first and last mile for those who travel by train.

I've heard a few times now that Bike Share will help to bridge that last mile. While I have no doubt that it will help, it will only help those who live and work close to Bike Share locations, I live in Santa Clara, about two miles away from the Caltrain station. As far as I know, there is no plan yet to put any Bike Share bikes in Santa Clara. If ever we get some, I don't know whether there'll be a anywhere near my home.

I'm all in favor of secure bike parking at stations, too, but often I'd like my bike at both ends of my trip. For nearby trips (Palo Alto, Mountain View) I also use Caltrain to go one way, and ride the other way on my bike.

Even on weekends, when I most often use Caltrain, events can make for crowds in bike cars.

Thanks for your consideration,

Betsy Megas  
Santa Clara resident, bike commuter, Caltrain rider

## McKenna, Nancy

---

**From:** Kristen Azevedo <azevedo1@stanford.edu>  
**Sent:** Thursday, July 02, 2015 9:36 AM  
**To:** Board (@caltrain.com); cacsecretary (@caltrain.com); Caltrain, Bac (@caltrain.com)  
**Cc:** janice@sfbike.org; bikesonboard@sfbike.org  
**Subject:** I Support More Bike Space On Board and More Bike Parking for Caltrain

Dear Caltrain Board,

As a fellow bike commuter, I urge you to pass a design that provides bike capacity for at least 16 percent of Caltrain passengers. Please also support the transit agency, making it an official goal that at least 20 percent of Caltrain passengers will access the system by bike by 2020.

Please extend a huge 'thank you' to your staff for recommending a significant \$3 million investment in securing bike parking; I encourage the Board to approve this recommendation.

Thanks for your consideration and support of Caltrain bike commuters!  
Kristen

**Kristen Azevedo**

Director, Student-Athlete Leadership & Development  
Stanford University  
[kristen.azevedo@stanford.edu](mailto:kristen.azevedo@stanford.edu)  
650.723.5013  
[gostanford.com](http://gostanford.com) | (800)-STANFORD

## McKenna, Nancy

---

**From:** Manzanera, Fernando@DOT <fernando.manzanera@dot.ca.gov>  
**Sent:** Thursday, July 02, 2015 8:33 AM  
**To:** Board (@caltrain.com); cacsecretary (@caltrain.com); Caltrain, Bac (@caltrain.com)  
**Cc:** janice@sfbike.org; bikesonboard@sfbike.org; Gronemeyer, Brett A@DOT  
**Subject:** Caltrain's new car design decisions  
**Attachments:** Caltrain's bad decisions.pdf

Dear Sirs,

Just read this article and it appears to me that Caltrain is going to make a couple of bad decisions with their new electrical trains design.

Providing more bicyclist capacity is imperative to increase ridership. To convince people to ride the trains they need a reliable means of transportation to and from the station. There would never be a bus network dense enough, plus buses are very expensive for the taxpayer.

And eliminating bathrooms? With no bathrooms in the stations, people will drive instead and not ride the trains, unless they are very short stints.

If you need to maximize space in the railcars, reduce the number of seats. People can stand by their bicycle. Please avoid these design flaws in the next generation of trains.

Thanks.

Fernando Manzanera, M.S., P.E.  
Caltrans District 01, Hydraulics  
(707)445-5322

**Organization:** California Department of Transportation**Date:** 7/1/2015

[Bicyclists push for more room on Caltrain: Activists worry new car design won't aid capacity, restrooms to be removed](#)

(Wednesday,07/01/2015 © San Mateo Daily Journal)

July 01, 2015, 05:00 AM By Samantha Weigel Daily Journal

As Caltrain prepares for a massive system overhaul and electrification of the tracks, some are concerned the design of the transit agency's new rail cars could leave more bicyclists at the wayside.

The Caltrain Board of Directors is meeting Thursday to discuss soliciting bids from engineers to design its new electrified rail cars, or electric multiple units, slated to hit the tracks over the next decade.

In its draft request for proposals, Caltrain indicates it won't increase the ratio of bike capacity and may do away with onboard restrooms as it seeks to make room for riders of all modes.

The new cars are a vital component of the Caltrain Modernization Program, a more than \$1.5 billion project aimed at accounting for projected ridership growth, reducing greenhouse gas emissions as well as sharing 51 miles of tracks between San Jose and San Francisco with high-speed rail.

Yet bike-toting passengers who are frequently bumped from their scheduled trains due to a lack of space argue the design specifications are inadequate as the new trains don't significantly increase room for bicyclists.

There's not enough bike capacity today, said Shirley Johnson, a volunteer with the San Francisco Bicycle Coalition and leader of its Bikes Onboard project. The increase in bike boardings is three times higher than the increase in walk-on boardings. So by 2020, ridership projections show 20 percent will bring a bike on board. But that will only happen if Caltrain increases bike space on board.

Caltrain will consider instructing manufacturers to maintain a 1-to-9 ratio of bikes to traditional passengers a slight increase from the train's current 1-to-10 ratio but the same percentage after it puts its newly purchased used-diesel cars online in the coming years.

The new electrified trains are anticipated to replace about 75 percent of the current diesel fleet when electrification goes into effect around 2020. While Caltrain would like to accommodate as many bicyclists as possible, it must consider the most efficient way to increase capacity across the board, said Caltrain spokeswoman Jayme Ackemann, who noted each bicyclist takes up two seats.

We know we're already effectively at capacity today at our peak commute. With congestion on [Highway] 101 only projected to increase, we expect more demand for our services. So we're really trying to figure out how can we allocate the space on board these vehicles to ensure we get the greatest number of people on board, Ackemann said.

To maximize space, Caltrain is considering removing on-board restrooms, which require the space of at least eight seats, Ackemann said.

Regardless of the 1-to-9 ratio remaining as is, increasing ridership capacity across the board will mean space for more bicyclists, who currently make up about 13 percent of Caltrain's customers, Ackemann said. With each bicyclist taking the space of two seats but only paying for one ticket, Ackemann said Caltrain must consider all riders as it works within its limited budget.

Johnson argues providing more space for bicyclists is not only better for the environment as they don't drive to the station, it's better for the economy as they're not using tax-payer subsidized Caltrain shuttles which can run \$6 per person per trip or buses.

The bicyclist does not use publicly subsidized transportation at either end of their trip. So the bicyclist on the train can actually be more cost effective than someone who drives or takes the bus on both ends of their trip, Johnson said.

Caltrain has approximately \$700 million currently budgeted to replace a portion of its diesel fleet with electric trains and ultimately, the design of the trains may change over the next few decades. For now, Caltrain needs to at least have minimum requirements so it can begin the process of selecting and receiving input from potential manufacturers, Ackemann said.

This is a guiding principle for today, because you have to create a target, Ackemann said. We have routinely created additional space for bikes on board the trains when we have identified the opportunity, the equipment and the need to do so. So this is by no means is the final word of how much bike space will be on the train.

Ackemann noted how it dedicated a portion of its recently purchased refurbished Bombardier cars to bicyclists, which will allow for up to three bike cars on several trains. Currently, most trains have at least two bike cars with the older Gallery trains able to transport up to 80 bicyclists and the newer Bombardier trains carrying 48.

By voting on a set bike-to-seated-passenger ratio and opting to remove the restrooms, Johnson said the Caltrain Board of Directors is making a decision that will stick with the transit agency for decades to come.

Johnson noted removing the restrooms to which many are already accustomed, particularly rowdy Giants fans who are allowed to drink alcohol on the train, would be a disservice to users.

Although Caltrain doesn't have plans to improve or add restrooms at its stations, Bay Area Rapid Transit does not have restrooms on its trains or stations either, Ackemann said.

Johnson said many are grateful for the service Caltrain provides, particularly as people look for ways to avoid traffic and improve the environment. But with transit-oriented developments continuing throughout the rail corridor, Johnson said Caltrain is at risk of becoming unreliable and more people will turn to their cars.

Bicyclists are frustrated because they're trying to do the right thing for the environment and the right thing for the economy and the right thing for themselves because they're getting exercise when they commute. But when they get denied boarding by being bumped off the train, they're frustrated, Johnson said. We really do appreciate the system, because it's such a wonderful service, but it's frustrating when it doesn't work.

The Caltrain Board of Directors will vote on issuing its request for proposals for the design of the electric trains at its meeting beginning 10 a.m. Thursday, July 2, at its headquarters, 1250 San Carlos Ave., San Carlos. Visit [caltrain.com](http://caltrain.com) for more information.

[samantha@smdailyjournal.com](mailto:samantha@smdailyjournal.com)

(650) 344-5200 ext. 106



## McKenna, Nancy

---

**From:** Georgia Andrews <and.georgia.m@gmail.com>  
**Sent:** Wednesday, July 01, 2015 9:19 PM  
**To:** Board (@caltrain.com)  
**Cc:** bikesonboard@sfbike.org; Nabong, Sarah; Murphy, Seamus; cacsecretary (@caltrain.com); Caltrain, Bac (@caltrain.com)  
**Subject:** Bikes on board, bathrooms - July 2nd board meeting

Hi Caltrain Board,

This may be a little late, but hopefully not.

I'm writing to encourage you to increase bike capacity as we transition to the new equipment & electrification and to reconsider the removal of all bathrooms from the train.

I commute on Caltrain daily from San Francisco to Hillsdale, and I always bring my bike on board. I have a "last mile" problem at both ends - 1.5 miles and no convenient bus in San Francisco, and 2 miles with a very slow and infrequent shuttle in San Mateo. While increasing secure station bike parking would be helpful for many commuters, most people who bring their bike on board need it at both ends like I do.

I'm lucky enough not to get bumped regularly due to my schedule, but as more and more people carry their bikes on that will probably change. And every time bike capacity is added, it's filled, showing a clear demand for more bicycle space on board trains. In addition, I remember the train rider surveys mostly being done in the winter, which is the lowest time for bicycle usage. Every summer, consistently for the 4 years I've been riding Caltrain, the bike cars hit capacity much more often and much earlier in the trip.

In addition, there are a huge number of advantages to encouraging bicycles on board, detailed in the Bikes On Board report here: [https://www.sfbike.org/wp-content/uploads/2015/05/Presentation\\_Bikes\\_on\\_Electrified\\_Trains\\_SFBC\\_v1.pdf](https://www.sfbike.org/wp-content/uploads/2015/05/Presentation_Bikes_on_Electrified_Trains_SFBC_v1.pdf), which I'm sure you've already seen.

And a quick note about the bathrooms. I rarely use them on my short commute, but I've used them much more frequently on weekend trips, when I often go to Palo Alto or further south and I'm on the train for over an hour. One of my biggest concerns (and a potential source of complaints) is the inevitable result of drunk sports fans being on the train in dire need of a bathroom. And decide to make do with the trash can, or a bottle, or something equally or more disgusting. It's also an enormous inconvenience on midday or weekend trains when the next train is in an hour, and very few stations have bathrooms. Every car having a bathroom is probably overkill. 2 per train would be sufficient in most cases.

Thank you,

Georgia Andrews  
San Francisco resident

--

Women Who Code San Francisco City Director  
[womenwhocode.com](http://womenwhocode.com)

## McKenna, Nancy

---

**From:** Greg Miller <gregorsound@gmail.com>  
**Sent:** Wednesday, July 01, 2015 9:01 PM  
**To:** Board (@caltrain.com); cacsecretary (@caltrain.com); Caltrain, Bac (@caltrain.com)  
**Cc:** janice@sfbike.org; bikesonboard@sfbike.org  
**Subject:** I Support More Bike Space On Board and More Bike Parking for Caltrain

Hi

Please prioritize bicycle access to caltrain. We're seeing a dramatic increase in ridership. Please anticipate 20% of caltrain riders to access via bicycle by 2020.

Thank you

Greg Miller  
Location Sound  
[www.gregorsound.com](http://www.gregorsound.com)  
415-238-1242

## McKenna, Nancy

---

**From:** Adrienne Hickman <adrienne152@earthlink.net>  
**Sent:** Wednesday, July 01, 2015 5:02 PM  
**To:** Board (@caltrain.com); cacsecretary (@caltrain.com); Caltrain, Bac (@caltrain.com)  
**Cc:** janice@sfbike.org; bikesonboard@sfbike.org  
**Subject:** Bike Capacity on Access on Electric Multiple Units

To: Caltrain Joint Powers Board of Directors

It is essential that Californians reduce greenhouse gas emissions by using public transportation (Caltrain, etc.) and bicycles instead of private automobiles. By the year 2020 I hope that we will understand the urgency of changing our behavior as we try to reduce the effects of climate change caused by greenhouse gas emissions. To that end, Caltrain can contribute to the solution by

- Passing a design for the new cars provide bike capacity for at *least* 16 percent of Caltrain passengers;
- making it an official goal that at least 20 percent of Caltrain passengers will access the system by bike by 2020; and
- approving the recommendation of Caltrain staff to invest \$3 million in secure bike parking.

Thank you to the board and Caltrain staff for the progress you have made thus far in making Caltrain bicycle friendly.

Yours very truly,  
Adrienne Hickman

## McKenna, Nancy

---

**From:** md <merdenton@aol.com>  
**Sent:** Wednesday, July 01, 2015 3:14 PM  
**To:** Board (@caltrain.com); cacsecretary (@caltrain.com); Caltrain, Bac (@caltrain.com)  
**Cc:** janice@sfbike.org; bikesonboard@sfbike.org  
**Subject:** I Support More Bike Space On Board and More Bike Parking for Caltrain

Hello Caltrain Board,

I understand that you will be meeting tomorrow to discuss Bikes on Caltrain. First, thank you for prioritizing bikes and having cars for bikes. For the past year, I have been able to wake up and feel so excited that I have the opportunity to bike commute to work 2-3x per week. What a blessing! However, with this blessing there is caution because I am never entirely sure if there will be room for my bike or my body on the train. In general, I feel "lucky" that I take the earlier trains and do not commute at the most heavy times. When there is room, it usually means wiggling through many bikes with little room to fit on the floor or along the racks. As bikers, we all breathe, make room the best that we can, and climb over ourselves and our bikes. It is a friendly group for sure...but it would be nice if there was a little more ease in this process of commuting.

For the benefit of all bike commuters, I advocate for the following:

- 1) Larger signs for people to know that bike cars are for bicyclists. Many non-bikers take up the seats in the bike car and do not bother seeing the little signs that request that the cars are for bicyclists. It would be amazing to actually sit down but this feels like a miracle, more often than not.
- 2) More bike cars. this would allow for more bicyclists to ride. Good group to have more of on your trains anyway :)
- 3) more secure parking for bikes. We have these amazing 2 wheels and might as well lock them up so we can keep riding.

Thank you very much,

I look forward to commuting more with you in the future,

With gratitude and kindness,  
Meredith

## McKenna, Nancy

---

**From:** Jonathan Dirrenberger <jonathan.dirrenberger@gmail.com>  
**Sent:** Wednesday, July 01, 2015 3:12 PM  
**To:** Board (@caltrain.com); cacsecretary (@caltrain.com); Caltrain, Bac (@caltrain.com)  
**Cc:** Janice Li; bikesonboard@sfbike.org  
**Subject:** I Support More Bike Space On Board and More Bike Parking for Caltrain

Caltrain Board,

I have been riding Caltrain every day for 8 years from my home in SF to my job in Palo Alto. I have also been bringing my bicycle on-board this entire time and hence have a \*lot\* of experience with Caltrain and bicycles (I would posit to say more than probably every Caltrain Board or staff member). I greatly appreciate the effort Caltrain has made to accommodate bicycles, but having:

- been bumped dozens and dozens of times (and would have been bumped more but I have shifted my schedule to try and avoid rush hour trains as much as possible),
- watched the limited seats in the bicycle cars taken by non-bicyclists, and
- having been treated as a second-class passenger by the conductors who seem to think its the bicyclists' fault that boarding can be slow when there is a lack of space and when non-bicyclists are taking precious space in the bike car,

I vehemently support more bicycle space when the new, electrified cars are designed and built. The current situation is unacceptable during rush hour and any future plans which do not increase bicycle capacity (especially since nearly every city down the Peninsula Corridor is worked to increase the number of trips by bicycle) is flawed. Caltrain must recognize that there is a huge health and environmental savings for the Bay Area at-large by encouraging passengers to use their bicycles at both ends of their Caltrain trip. Further, though a passenger with their bicycle takes up more space on the train than a non-bicyclist, this is offset by the need for less parking spaces at Caltrain stations as well as less crowding and space needed for shuttles. Caltrain must recognize that this trade-off is inline with future expected growth in non-automobile forms of transportation and ultimately will benefit Caltrain and its passengers.

Note that bike share or bike lockers at stations will never be a solution for many bicyclists who either get on/off at different stations (as I do), need their bicycle throughout the day (as I do), where their destination is not near bike share (as is the case for me and which is usually the case anywhere but in SF), or where they cannot afford having more than one bicycle (to store one at each end). Thus, any real solution must accommodate more bicycles on-board.

As a result, I urge the Caltrain Board to pass a design for the new cars that provides bicycle capacity for at least 16% of Caltrain passengers. I also support the transit agency making it an official goal that at least 20% of Caltrain passengers access the system by bicycle by 2020.

Finally, I want to thank the Caltrain staff for recommending a significant \$3 million investment in secure bicycle parking and encouraging the Caltrain Board to approve this recommendation.

Please make sure that Caltrain keeps up with the growth of bicycling in the Bay Area and continues to lead the nation in sustainable transit and help Bay Area communities become more livable, healthy, and enjoyable.

Thanks for your time,

## McKenna, Nancy

---

**From:** Mary Duffy <mduffy@technoqueens.com>  
**Sent:** Wednesday, July 01, 2015 1:44 PM  
**To:** Board (@caltrain.com); cacsecretary (@caltrain.com); Caltrain, Bac (@caltrain.com)  
**Cc:** janice@sfbike.org; bikesonboard@sfbike.org  
**Subject:** I Support More Bike Space On Board and More Bike Parking for Caltrain

Dear Caltrain Board Members,

I am a regular Caltrain commuter and I ride my bike and take it onboard the train to San Francisco. My station is South San Francisco and every time I try to get onboard in the morning, it is doubtful that I will be able to bring my bike because the bike car is full almost beyond capacity. Because of the number of bikes, not only is it difficult to get onboard, it is very difficult to unload.

I know that if there was regular space on board the bike cars, people would be more likely to get out of their cars and drive to work. However, with the increase in ridership, if there are not accommodations for bikes, folks will more than likely drive.

So I urge you to pass a design that allows for at least 16 percent bike capacity on the trains so we can continue to utilize this vital transit option, as well as minimize the number of cars on the road.

I also strongly support the idea of providing secure bike parking. For me, that would mean I would not have to put the bike on the train, because I only need to ride it to and from the station.

Thank you for consideration and support.

Sincerely,

Mary Duffy

## McKenna, Nancy

---

**From:** Jana Zanetto <jzanetto@gmail.com>  
**Sent:** Wednesday, July 01, 2015 1:44 PM  
**To:** Board (@caltrain.com); cacsecretary (@caltrain.com); Caltrain, Bac (@caltrain.com)  
**Cc:** janice@sfbike.org; bikesonboard@sfbike.org  
**Subject:** I Support More Bike Space On Board and More Bike Parking for Caltrain

Dear Caltrain Board members,

I am writing you to urge you to increase space for cyclists on the new electrified cars. As a 65-year old cyclist and longtime bike commuter, I appreciate the efforts throughout the Bay Area to facilitate bike travel. I no longer take Caltrain very often, as I have moved from San Francisco to Marin County, but I did find Caltrain immensely helpful in reaching my Peninsula destinations, whether for business or pleasure. However, access for cyclists on Caltrain was often quite impacted, especially at am and pm rush hours, causing frustration for those of us counting on boarding and then being turned away and told to wait for the next train.

As more employers have relocated in the peninsula Caltrain corridor, the number of biking transit users has continued to mount. I urge you to designate bike capacity for at least 15% of Caltrain passengers and hope you will also make it an official goal to increase that number to at least 20% of Caltrain passengers by 2020.

As a victim of a bike theft at an unsecured BART station, I want to thank the Caltrain staff for recommending that \$3 million be invested in secure bike parking at Caltrain stations and encourage you to approve this recommendation.

Thank you very much for considering my opinions.

Jana Zanetto  
San Rafael

## McKenna, Nancy

---

**From:** Rick Cox <rick.cox@gmail.com>  
**Sent:** Wednesday, July 01, 2015 9:59 AM  
**To:** Board (@caltrain.com); cacsecretary (@caltrain.com); Caltrain, Bac (@caltrain.com)  
**Cc:** janice@sfbike.org; bikesonboard@sfbike.org  
**Subject:** Bicycle Access (and bathrooms) on new trains

Caltrain Board and Staff,

As a Caltrain rider for the last 10 years, and user of the 4th & King bike station for the last 5 years, I would like to begin by thanking the Board and Caltrain staff for the bike access that is currently available. The 4th & King bike station is an amazing facility, and for those times when I can't use it (weekends, when I need to be at work early or late, or when I need to use my bike during the day), the ability to bring my bike on-board is very much appreciated. Caltrain has long been a leader in bike access, and that is reflected in the number of passengers now using a bike to connect with the train.

I am very happy to see the staff recommendation for \$3 million to fund additional secure station bicycle parking. I believe that would be a great investment, increasing ridership, improving sustainability, and reducing competition for bike space on-board trains.

I would also like to ask the Board to support a 16% on-board bicycle capacity target. I know the trains are crowded and recognize this is a tradeoff. However, as communities all along the Caltrain corridor make their cycle routes safer and attractive to ever more of their population, I believe the current trend toward more people combining biking and trains will accelerate. Bike parking, bike share systems, and other off-board options will only be able to accommodate a fraction of this growth. If the on-board space is frequently at capacity, as it is today, this will be a frustrating experience, and passengers will choose other options (like driving alone!).

Finally, I would like to ask the Board to include one bathroom in the new train sets. While not necessary on an average commute, not all commutes are average, and not all trips are commutes. When there are system delays, or I'm on a slow late night local, or I'm coming home from a day out and about, sometimes the bathroom makes a big difference.

Thank you,  
Richard Cox  
San Francisco, CA



## McKenna, Nancy

---

**From:** Zlatko Unger <zlatkounger@gmail.com>  
**Sent:** Wednesday, July 01, 2015 9:32 AM  
**To:** Board (@caltrain.com)  
**Cc:** bikesonboard@sfbike.org; Nabong, Sarah; Murphy, Seamus; cacsecretary (@caltrain.com); Caltrain, Bac (@caltrain.com)  
**Subject:** Please increase the bike capacity on electrified trains

Dear Caltrain Board,

In my short little time living in the bay area there are lots of uncertainties that I had to deal with during my commute. Will the train show up on time? Will there be Giants fans overcrowding the train? Will someone leave their car on the train tracks and cause a delay? And more recently, will I be able to get my bike on the train today? I commute 7-10 miles every day, and don't have a car, nor have access to a bike share near my office. I like to keep my uncertainties limited, and that's why I depend on my bike and Caltrain. It is the most economic way for me to get to work. Over the past few months, I have started getting on earlier and earlier to the platform to beat other bikers. Now, after a few bumps due to the limits you impose on your conductors, I have to get on earlier trains. It is only a matter of time until it becomes overcrowded as well.

As SFBA continues to boom, the number of riders on Caltrain will increase. A portion of those riders will be bikers. Those bikers will get bumped from train to train as the Caltrain conductors prevent them from getting on. The only way to solve this is to prepare the trains to take on more bikers. Adding more trains--as that is your current plan--might work for some, while it will be a pain for those depending on Baby Bullets to and from San Francisco.

I believe that Caltrain can reclaim its awesomeness with the biking commuters. By adding extra bike capacity, you will allow more people to commute to work on their bikes. This will decrease the number of cars on the road, which will improve the overall congestion in the bay area. Please overturn the staff's recommendation to keep the capacity on the new trains the same.

Thank you for your time,

Zlatko from Redwood City

## McKenna, Nancy

---

**From:** Michelle Glauser <michelleglauser@gmail.com>  
**Sent:** Wednesday, July 01, 2015 9:33 AM  
**To:** Board (@caltrain.com); cacsecretary (@caltrain.com); Caltrain, Bac (@caltrain.com)  
**Cc:** janice@sfbike.org; bikesonboard@sfbike.org  
**Subject:** For a Bike-Friendly Caltrain

To Whom It May Concern:

I hear that some big decisions are being made about how bike-friendly Caltrain is going to be in the future. As someone who is proud to have a Caltrain label flapping on my bike everywhere I go, I'd like to encourage that:

- As much bike capacity as possible is provided (20%+)
- The goal of at least 20% of passengers accessing the system by bike by 2020 is set
- Continued investments in secure bike parking are made

Thanks for making Caltrain as bike-friendly as possible.

Sincerely,

Michelle Glauser

## McKenna, Nancy

---

**From:** Ellen Koivisto & Gene Thompson <offstage@earthlink.net>  
**Sent:** Wednesday, July 01, 2015 9:14 AM  
**To:** Board (@caltrain.com); cacsecretary (@caltrain.com); Caltrain, Bac (@caltrain.com)  
**Cc:** janice@sfbike.org; bikesonboard@sfbike.org  
**Subject:** I Support More Bike Space On Board and More Bike Parking for Caltrain

- I strongly urge the Caltrain Board to pass a design that provides bike capacity for at least 16 percent of Caltrain passengers and 20% would be much better (more in line with percent ridership that tries to use bikes on Caltrain);
- I support the transit agency making it an official goal that at least 20 percent of Caltrain passengers will access the system by bike by 2020, though 30 percent or higher would be more appropriate; and
- I would like to thank Caltrain staff for recommending a significant \$3 million investment in secure bike parking and encourage the Board to approve this recommendation.

Ellen Koivisto

## McKenna, Nancy

---

**From:** Shirley Johnson <dr\_shirley\_johnson@yahoo.com>  
**Sent:** Wednesday, July 01, 2015 9:07 AM  
**To:** Board (@caltrain.com)  
**Cc:** Caltrain, Bac (@caltrain.com); cacsecretary (@caltrain.com); Janice Li; Emma Shlaes; Steve Vanderlip; Murphy, Seamus  
**Subject:** Caltrain Bicycle Bump Report for June 2015  
**Attachments:** Caltrain Bicycle Bump Reports\_for\_JPB\_201506.xlsx; BicycleBumpGraph\_June2015.docx

Dear Joint Powers Board,

Please find attached the bicycle bump report spreadsheet for June and a graph of reported bumps over the past year. The total number of unique bicycle bumps reported in June 2015 was 199, a 5% increase compared with June 2014. This high bump count emphasizes the importance of adding a third bike car to Bombardier trains, and we thank you again for the decision to add the third bike car once the Metrolink cars have been refurbished.

Some important notes about bump reporting:

1. SFBC released a bump report form on February 12, 2015 (see [sfbike.org/bumpform](http://sfbike.org/bumpform)). Much to our surprise, Caltrain released a bump report form on March 5, 2015 (see <http://www.caltrain.com/riderinfo/Bicycles/BikeBumpForm.html>). The forms take the place of emails to report bumps.
2. The SFBC's form populates a publicly available spreadsheet in real time at [sfbike.org/bumpreports](http://sfbike.org/bumpreports). Caltrain's form sends a tweet via Twitter @BikesOnCaltrain, but there is no associated publicly available spreadsheet of the data. Therefore, we automatically transfer the information from the tweet into our spreadsheet in real time. Caltrain's tweet does not include the total number of bumped bikes, so we add a cautionary note in the comments column of our spreadsheet.
3. Tweets from Caltrain's form do not include date of the bicycle bump. For the purpose of calculating the bump total, we assume the date of the tweet is the date the bump occurred, except as noted in number 4 below.
4. There is a known glitch in Caltrain's software that results in the last bump report of the day not being tweeted until the next morning. The spreadsheet at [sfbike.org/bumpreports](http://sfbike.org/bumpreports) has been edited to correct for this glitch. The attached downloaded spreadsheet notes the corrected rows in the "Editor Comments" column.

We have communicated with Caltrain to collaborate on bump reporting to produce a Caltrain-managed bump reporting method to avoid confusion and provide the most complete information possible for Caltrain customers and staff. We look forward to advancing our collaboration with Caltrain.

Best regards,  
Shirley Johnson  
Leader, BIKES ONboard project

**Customer-Reported Bicycle Bumps in June 2015**

**Total Unique Bumps Reported: 199**

Spreadsheet available at [www.sfbike.org/bumpreports](http://www.sfbike.org/bumpreports)

Editor comments	Timestamp for bump report	Date of bicycle bump(s)	Total number of bumped bikes	Departure station	Travel direction	Scheduled departure time	Train number	Train type	Comments
Not included in June total.	6/8/2015 17:38:45	05/29	1	Burlingame	North	8:37am	225	Gallery	Caltrain board,  I am a daily Caltrain bike commuter to work and I was again denied boarding on a bombardier car on Northbound Caltrain#225 from Burlingame station on 5/29. I have experienced this multiple times, and this customer experience is unacceptable. Please take action to increase bicycle capacity as soon as possible.  Thanks, Elaine Lee  —  Elaine Lee ■ Technical Project Manager, DevOps  1161 Mission St, Ste 410   San Francisco, CA 94103 p +1 415 861 9300   m +1 650 395 8420 e elee@gopro.com
Due to known glitch in Caltrain's software, date of bicycle bump changed from 6/1 to 5/30. Not included in June total.	6/1/2015 9:37:06	05/30	1	California Avenue	North	8:11 am			CAUTION: There may have been more than one bump! Transferred from Twitter @BikesOnCaltrain: 'A cyclist was bumped at California Ave NB at 8:11 am. #Caltrain' id:605412593340190721
Due to known glitch in Caltrain's software, date of bicycle bump changed from 6/1 to 5/30. Not included in June total.	6/1/2015 18:03:39	05/30	1	San Mateo	North	8:32 am	225		CAUTION: There may have been more than one bump! Transferred from Twitter @BikesOnCaltrain: 'A cyclist was bumped at San Mateo NB 225 at 8:32 am. #Caltrain' id:605539912146780160
	6/1/2015 8:40:42	6/1	3	Hillsdale	North	8:28am	225	Gallery	I was the second biker to arrive at Hillsdale, but got jumped and bumped due to other bikers.
	6/2/2015 18:35:44	06/01	3	Menlo Park	North	5:57pm	277	Gallery	No bikes were allowed on the train.
Due to known glitch in Caltrain's software, date of bicycle bump changed from 6/2 to 6/1.	6/2/2015 8:04:12	06/01	1	Menlo Park	North	6:19 pm	279		CAUTION: There may have been more than one bump! Transferred from Twitter @BikesOnCaltrain: 'A cyclist was bumped at Menlo Park NB 279 at 6:19 pm. #Caltrain' id:605751540620640256
	6/2/2015 18:37:35	06/01	5	Menlo Park	North	6:16PM	279	Gallery	This was the second train I was bumped from. After this I gave up and decided to try to ride to my destination instead. Very frustrating.
	6/1/2015 8:20:34	06/01	1	Palo Alto	North	8:05 am			CAUTION: There may have been more than one bump! Transferred from Twitter @BikesOnCaltrain: 'A cyclist was bumped at Palo Alto NB at 8:05 am. #Caltrain' id:605393455280496644
Repeat report. Omitted from total.	6/1/2015 18:26:10	06/01	1	Redwood City	North	5:53 pm	375		CAUTION: There may have been more than one bump! Transferred from Twitter @BikesOnCaltrain: 'A cyclist was bumped at Redwood City NB 375 at 5:53 pm. #Caltrain' id:605545833203789824

	6/2/2015 8:07:30	06/01	4	Redwood City	North	5:53pm	375	Gallery	There appeared to be spots remaining on the north car, and a few bikes were getting off. However, the conductor was not allowing any bikes on board. The car ended up being filled with standing Giants fans. Very frustrating.  Running back to the southern bike car, the conductor was willing to let a few on, but she at least knew how many spots were available.
	6/2/2015 19:08:15	06/02	4	Menlo Park	North	6:46pm	385	Gallery	Were told to go to back car from North most car before any bikes got off the train. Could clearly see 4 open spots in North car through window. Rear car took 1 passenger. 4 bumped total.
	6/2/2015 10:26:36	06/02	1	Mountain View	North	7:57 am			CAUTION: There may have been more than one bump! Transferred from Twitter @BikesOnCaltrain: 'A cyclist was bumped at Mountain View NB at 7:57 am. #Caltrain' id:605787521927114753
	6/3/2015 8:21:47	6/3	1	Hillsdale	North	8:16am	323	Bombardier	Typical bump. I arrived as the train arrived. Plenty of time for me to get on, conductor waved Hus hand by his neck "cut off".
Due to known glitch in Caltrain's software, date of bicycle bump changed from 6/3 to 6/2.	6/3/2015 7:20:40	06/03	1	Redwood City	North	5:53 pm	375		CAUTION: There may have been more than one bump! Transferred from Twitter @BikesOnCaltrain: 'A cyclist was bumped at Redwood City NB 375 at 5:53 pm. #Caltrain' id:606103008766750720
Due to known glitch in Caltrain's software, date of bicycle bump changed from 6/4 to 6/3.	6/4/2015 17:18:20	06/03	1	Sunnyvale	North	7:13 am	319		CAUTION: There may have been more than one bump! Transferred from Twitter @BikesOnCaltrain: 'A cyclist was bumped at Sunnyvale NB 319 at 7:13 am. #Caltrain' id:606615839291285506
	6/4/2015 19:01:30	06/04	1	4th & King	South	5:14 pm	370		CAUTION: There may have been more than one bump! Transferred from Twitter @BikesOnCaltrain: 'A cyclist was bumped at San Francisco SB 370 at 5:14 pm. #Caltrain' id:606641809901494272
Due to known glitch in Caltrain's software, date of bicycle bump changed from 6/8 to 6/5.	6/8/2015 17:37:46	06/05	1	Hillsdale	South	5:40 pm	370		CAUTION: There may have been more than one bump! Transferred from Twitter @BikesOnCaltrain: 'A cyclist was bumped at Hillsdale SB 370 at 5:40 pm. #Caltrain' id:608070230485659648
	6/8/2015 17:41:04	06/08	1	4th & King	South	5:33 pm	376		CAUTION: There may have been more than one bump! Transferred from Twitter @BikesOnCaltrain: 'A cyclist was bumped at San Francisco SB 376 at 5:33 pm. #Caltrain' id:608071151999283200
Due to known glitch in Caltrain's software, date of bicycle bump changed from 6/9 to 6/8.	6/9/2015 7:19:49	06/08	1	4th & King	South	5:33 pm	376		CAUTION: There may have been more than one bump! Transferred from Twitter @BikesOnCaltrain: 'A cyclist was bumped at San Francisco SB 376 at 5:33 pm. #Caltrain' id:608277281065148417

	6/8/2015 17:40:21	06/08	1	Burlingame	North	8:37am	225	Gallery	<p>Caltrain board,</p> <p>I am a daily Caltrain bike commuter to work and I was again denied boarding on a bombardier car on Northbound Caltrain#225 from Burlingame station today. Several bike were denied boarding for both bike cars. I have experienced this multiple times, and this customer experience is unacceptable. Please take action to increase bicycle capacity as soon as possible.</p> <p>Thanks, Elaine Lee</p> <p>—</p> <p>Elaine Lee ■ Technical Project Manager, DevOps</p> <p>1161 Mission St, Ste 410   San Francisco, CA 94103 p +1 415 861 9300   m +1 650 395 8420 e elee@gopro.com</p>
Repeat report. Omitted from total.	6/9/2015 7:24:14	06/09	1	22nd Street	South	7:19 am	314		CAUTION: There may have been more than one bump! Transferred from Twitter @BikesOnCaltrain: 'A cyclist was bumped at 22nd St SB 314 at 7:19 am. #Caltrain' id:608278349039869953
	6/9/2015 7:24:31	6/9	12	22nd Street	South	7:19am	314	Bombardier	Defeats the point of the bicycle/train commute.
	6/9/2015 18:21:00	06/09	1	4th & King	South	5:33 pm	376		CAUTION: There may have been more than one bump! Transferred from Twitter @BikesOnCaltrain: 'A cyclist was bumped at San Francisco SB at 5:33 pm. #Caltrain' id:608443444860710914
Repeat report. Omitted from total.	6/9/2015 8:48:45	06/09	1	Burlingame	North	8:37 am	225		CAUTION: There may have been more than one bump! Transferred from Twitter @BikesOnCaltrain: 'A cyclist was bumped at Burlingame NB 225 at 8:37 am. #Caltrain' id:608299685170835457
	6/9/2015 21:53:00	06/09	7	Burlingame	North	08:37am	225	Gallery	<p>Caltrain board,</p> <p>I am a daily Caltrain bike commuter to work and for the second consecutive day I was denied boarding on a gallery car on Northbound Caltrain#225 from Burlingame station today. Several bikes were denied boarding for both bike cars. I have experienced this multiple times, and this customer experience is unacceptable. Please take action to increase bicycle and overall passenger capacity as soon as possible.</p> <p>Thanks, Elaine Lee</p>
	6/18/2015 6:25:11	06/09	2	Hillsdale	North	5:08pm	267	Bombardier	The 3-bike car Bombardiers would have prevented this. I'm glad they are coming soon!
	6/9/2015 8:48:44	06/09	1	Hillsdale	North	8:16 am	323		CAUTION: There may have been more than one bump! Transferred from Twitter @BikesOnCaltrain: 'A cyclist was bumped at Hillsdale NB 323 at 8:16 am. #Caltrain' id:608299496401960960
	6/9/2015 8:05:04	6/09	1	San Jose Diridon	North	07:45 am	323	Bombardier	Happens often
	6/9/2015 17:49:51	06/09	2	San Mateo	North	5:36pm	269	Gallery	Now I will get home 45 minutes late. Thanks Caltrain for wasting my evening.

	6/9/2015 7:23:08	06/09	1	Sunnyvale	North	7:13 am	319		CAUTION: There may have been more than one bump! Transferred from Twitter @BikesOnCaltrain: 'A cyclist was bumped at Sunnyvale NB 319 at 7:13 am. #Caltrain' id:608277950434299904
Due to known glitch in Caltrain's software, date of bicycle bump changed from 6/11 to 6/10.	6/11/2015 8:12:28	06/10	1	Menlo Park	North	5:19 pm	269		CAUTION: There may have been more than one bump! Transferred from Twitter @BikesOnCaltrain: 'A cyclist was bumped at Menlo Park NB at 5:19 pm. #Caltrain' id:609015230824194048
	6/11/2015 8:12:29	06/11	1	Millbrae	South	8:01 am	220		CAUTION: There may have been more than one bump! Transferred from Twitter @BikesOnCaltrain: 'A cyclist was bumped at Millbrae SB at 8:01 am. #Caltrain' id:609015319269621762
	6/11/2015 8:14:42	06/11	1	Palo Alto	North	8:05 am	323		CAUTION: There may have been more than one bump! Transferred from Twitter @BikesOnCaltrain: 'A cyclist was bumped at Palo Alto NB at 8:05 am. #Caltrain' id:609015706341011456
	6/15/2015 8:41:54	06/15	6	Hillsdale	North	8:28am	225	Bombardier	Taking bike on Caltrain is an experience fraught with anxiety, and too often, disappointment.
	6/15/2015 8:02:02	06/15	1	Mountain View	North	7:57 am	323		CAUTION: There may have been more than one bump! Transferred from Twitter @BikesOnCaltrain: 'A cyclist was bumped at Mountain View NB 323 at 7:57 am. #Caltrain' id:610462163421913090
Due to known glitch in Caltrain's software, date of bicycle bump changed from 6/16 to 6/15.	6/16/2015 7:43:06	06/15	1	San Mateo	North	8:32 am	225		CAUTION: There may have been more than one bump! Transferred from Twitter @BikesOnCaltrain: 'A cyclist was bumped at San Mateo NB 225 at 8:32 am. #Caltrain' id:610819774763831296
	6/15/2015 18:43:18	06/15	2	San Mateo	North	6:36pm	279	Gallery	More bike cars.
	6/16/2015 19:01:44	06/16	5	Hillsdale	North	8:28am	225		Northbound train 225 arrived 5 minutes late and only allowed 4 bikes to board.  The 20+ minute gap between trains means that I'll now be late to work - at a new job, no less!  Bike cars have been full on every train I've ridden lately, spanning the full 3 hour morning commute window. The high risk of being bumped and therefor missing hours at work makes Caltrain less and less practical. Without a higher level of service / guarantee the people trying to maximize public transit and minimize highway driving will be left at the station. Which is awful.
	6/16/2015 7:55:11	06/16	12	Redwood City	North	7:45am	221	Gallery	Where is the third bike car? Each day gets more and more difficult for bikers to take the train. Please help meet our demand! We are helping to reduce emissions and improving our lifestyles.
	6/16/2015 17:39:08	06/16	4	Redwood City	North	5:25pm	269	Gallery	
	6/16/2015 7:35:43	06/16	12	Redwood City	North	7:30 am	319	Bombardier	
Repeat report. Omitted from total.	6/16/2015 7:45:18	06/16	1	Redwood City	North	7:30 am	319		CAUTION: There may have been more than one bump! Transferred from Twitter @BikesOnCaltrain: 'A cyclist was bumped at Redwood City NB 319 at 7:30 am. #Caltrain' id:610820339262566400
Repeat report. Omitted from total.	6/16/2015 7:45:19	06/16	1	Redwood City	North	7:30 am	319		CAUTION: There may have been more than one bump! Transferred from Twitter @BikesOnCaltrain: 'A cyclist was bumped at Redwood City NB at 7:30 am. #Caltrain' id:610820366710128641



	6/17/2015 17:14:01	06/17	1	Hillsdale	North	7:51 am	217		CAUTION: There may have been more than one bump! Transferred from Twitter @BikesOnCaltrain: 'A cyclist was bumped at Hillsdale NB 217 at 7:51 am. #Caltrain' id:611325836592050177
	6/17/2015 17:29:20	06/17	1	Menlo Park	North	5:19 pm	269		CAUTION: There may have been more than one bump! Transferred from Twitter @BikesOnCaltrain: 'A cyclist was bumped at Menlo Park NB 269 at 5:19 pm. #Caltrain' id:611329576858357760
	6/17/2015 8:02:49	06/17	1	Redwood City	North	7:30 am	319		CAUTION: There may have been more than one bump! Transferred from Twitter @BikesOnCaltrain: 'A cyclist was bumped at Redwood City NB at 7:30 am. #Caltrain' id:611186972791418880
Due to known glitch in Caltrain's software, date of bicycle bump changed from 6/22 to 6/19.	6/22/2015 7:16:54	06/19	1	Menlo Park	North	5:19 pm	269		CAUTION: There may have been more than one bump! Transferred from Twitter @BikesOnCaltrain: 'A cyclist was bumped at Menlo Park NB 269 at 5:19 pm. #Caltrain' id:612987591269330946
	6/22/2015 18:58:17	06/22	2	4th & King	South	6:20pm	282	Gallery	
Due to known glitch in Caltrain's software, date of bicycle bump changed from 6/23 to 6/22. Repeat report. Omitted from total.	6/23/2015 7:18:34	06/22	1	4th & King	South	6:20 pm	282		CAUTION: There may have been more than one bump! Transferred from Twitter @BikesOnCaltrain: 'A cyclist was bumped at San Francisco SB 282 at 6:20 pm. #Caltrain' id:613350282857091072
	6/22/2015 17:35:42	06/22	1	4th & King	South	5:33 pm	376		CAUTION: There may have been more than one bump! Transferred from Twitter @BikesOnCaltrain: 'A cyclist was bumped at San Francisco SB 376 at 5:33 pm. #Caltrain' id:613143350393225217
Due to known glitch in Caltrain's software, date of bicycle bump changed from 6/23 to 6/22.	6/23/2015 7:54:41	06/22	1	4th & King	South	5:33 pm	376		CAUTION: There may have been more than one bump! Transferred from Twitter @BikesOnCaltrain: 'A cyclist was bumped at San Francisco SB 376 at 5:33 pm. #Caltrain' id:613359320646881280
	6/22/2015 8:47:54	06/22	2	Burlingame	North	8:37am	225	Gallery	
	6/22/2015 8:38:48	06/22	6	Hillsdale	North	8:28am	225	Gallery	
	6/22/2015 7:52:35	06/22	2	Hillsdale	South	7:42am	314	Bombardier	There was room in the racks for more bikes since bikes were well stacked, but conductor was enforcing 4 bike/rack rule hard. Old grumpy conductor.
	6/22/2015 8:41:10	06/22	3	San Mateo	North	8:32am	225	Gallery	
	6/22/2015 7:18:01	06/22	1	Sunnyvale	North	7:13 am	319		CAUTION: There may have been more than one bump! Transferred from Twitter @BikesOnCaltrain: 'A cyclist was bumped at Sunnyvale NB 319 at 7:13 am. #Caltrain' id:612987636249174016

	6/23/2015 11:38:03	06/23	6	Burlingame	North	08:37am	225	Gallery	Caltrain board,  I am a daily Caltrain bike commuter to work and was denied boarding on a gallery car on Northbound Caltrain#225 from Burlingame station today, Tuesday, 6/23/15. Several bikes were denied boarding for both bike cars. I have experienced this multiple times, and this customer experience is unacceptable. Please take action to increase bicycle and overall passenger capacity as soon as possible. The trains are filled to an unsafe level and have passengers standing in the vestibules of all cars on the train by the time it arrives to Burlingame. There needs to be more cars per train and more trains running during peak commute times  Thanks, Elaine Lee
	6/23/2015 8:23:57	06/23	5	Hillsdale	North	8:16am	323	Gallery	The bumps are much more frequent and the number of bikes getting bumped is higher. This wastes valuable time in my day. We sorely need more bike capacity.
Repeat report. Omitted from total.	6/23/2015 8:42:47	06/23	1	Hillsdale	North	8:16 am	323		CAUTION: There may have been more than one bump! Transferred from Twitter @BikesOnCaltrain: 'A cyclist was bumped at Hillsdale NB 323 at 8:16 am. #Caltrain' id:613371621668098052
Due to known glitch in Caltrain's software, date of bicycle bump changed from 6/24 to 6/23.	6/24/2015 18:15:56	06/23	1	Lawrence	North	7:40 pm	193		CAUTION: There may have been more than one bump! Transferred from Twitter @BikesOnCaltrain: 'A cyclist was bumped at Lawrence NB 193 at 7:40 pm. #Caltrain' id:613878176331100161
	6/23/2015 20:21:36	06/23	1	Menlo Park	North	5:47 pm	375		CAUTION: There may have been more than one bump! Transferred from Twitter @BikesOnCaltrain: 'A cyclist was bumped at Menlo Park NB 375 at 5:47 pm. #Caltrain' id:613547302779666436
	6/23/2015 12:08:22	06/23	1	San Carlos	North	8:27 am	225		CAUTION: There may have been more than one bump! Transferred from Twitter @BikesOnCaltrain: 'A cyclist was bumped at San Carlos NB 225 at 8:27 am. #Caltrain' id:613423249570070528
Repeat report. Omitted from total.	6/23/2015 7:30:37	06/23	1	Sunnyvale	North	7:14 am	319		CAUTION: There may have been more than one bump! Transferred from Twitter @BikesOnCaltrain: 'A cyclist was bumped at Sunnyvale NB 319 at 7:14 am. #Caltrain' id:613353326323744768
	6/23/2015 8:11:53	06/23	11	Sunnyvale	North	7:13am	319	Bombardier	The train was full leaving SJ. Not a single bike was able to board the rear car.
	6/24/2015 18:19:14	06/24	1	4th & King	South	6:12 pm	380		CAUTION: There may have been more than one bump! Transferred from Twitter @BikesOnCaltrain: 'A cyclist was bumped at San Francisco SB at 6:12 pm. #Caltrain' id:613878996015693824
	6/24/2015 7:57:31	06/24	4	Sunnyvale	North	7:13 am	319	Bombardier	4 bikes bumped from the rear car. I was on the train and couldn't see the front car.
Due to known glitch in Caltrain's software, date of bicycle bump changed from 6/25 to 6/24. Repeat report. Omitted from total.	6/25/2015 16:17:48	06/24	1	Sunnyvale	North	7:13 am	319		CAUTION: There may have been more than one bump! Transferred from Twitter @BikesOnCaltrain: 'A cyclist was bumped at Sunnyvale NB 319 at 7:13 am. #Caltrain' id:614210698730586112
	6/25/2015 7:22:14	06/25	15	22nd Street	South	7:20am	314	Gallery	Bike car was overfull when train left San Francisco.
Repeat report. Omitted from total.	6/25/2015 7:23:32	06/25	1	22nd Street	South	7:19am	314	Bombardier	

	6/25/2015 7:17:42	06/25	1	4th & King	South	6:12 pm	380		CAUTION: There may have been more than one bump! Transferred from Twitter @BikesOnCaltrain: 'A cyclist was bumped at San Francisco SB at 6:12 pm. #Caltrain' id:614074724159782914
	6/25/2015 8:21:55	06/25	3	Hillsdale	North	8:16am	323	Bombardier	Atghhhhhghzmdhsns
	6/25/2015 18:55:58	06/25	5	Palo Alto	North	6:46pm	385	Gallery	5 unable to get on train. After a long day has just become 45 minutes longer.
Due to known glitch in Caltrain's software, date of bicycle bump changed from 6/27 to 6/26.	6/27/2015 16:46:01	06/26	1	4th & King	South	5:33 pm	376		CAUTION: There may have been more than one bump! Transferred from Twitter @BikesOnCaltrain: 'A cyclist was bumped at San Francisco SB 376 at 5:33 pm. #Caltrain' id:614942590824112128
	6/29/2015 19:02:13	06/29	1	4th & King	South	6:56 pm	288		CAUTION: There may have been more than one bump! Transferred from Twitter @BikesOnCaltrain: 'A cyclist was bumped at San Francisco SB at 6:56 pm. #Caltrain' id:615701837342060544
Due to known glitch in Caltrain's software, date of bicycle bump changed from 6/30 to 6/29.	6/30/2015 7:48:10	06/29	1	4th & King	South	5:14 pm	370		CAUTION: There may have been more than one bump! Transferred from Twitter @BikesOnCaltrain: 'A cyclist was bumped at San Francisco SB 370 at 5:14 pm. #Caltrain' id:615894411298213889
Repeat report. Omitted from total.	6/29/2015 18:47:59	06/29	1	Palo Alto	North	6:43 pm	385		CAUTION: There may have been more than one bump! Transferred from Twitter @BikesOnCaltrain: 'A cyclist was bumped at Palo Alto NB at 6:43 pm. #Caltrain' id:615698033888473091
	6/29/2015 18:48:33	06/29	3	Palo Alto	North	6:43 pm	385	Gallery	I'll get home ~40 minutes later than planned.
	6/30/2015 7:05:01	06/30	1	4th & King	South	6:56 pm	288		CAUTION: There may have been more than one bump! Transferred from Twitter @BikesOnCaltrain: 'A cyclist was bumped at San Francisco SB at 6:56 pm. #Caltrain' id:615883517491163137
	6/30/2015 9:16:29	06/30	5	Burlingame	North	8:37am	225	Gallery	This stinks. I have to ride home and walk back to Caltrain and then take the local. This adds a full 2 hours to my work day. Instead of getting in at 9:10. I'll get in around 11.
	6/30/2015 9:15:45	06/30	1	Hillsdale	South	7:52 am	314		CAUTION: There may have been more than one bump! Transferred from Twitter @BikesOnCaltrain: 'A cyclist was bumped at Hillsdale SB 314 at 7:52 am. #Caltrain' id:615916491574120450
	6/30/2015 8:01:29	06/30	6	Mountain View	North	7:57 am	323	Bombardier	Rear bike car, closest to locomotive. Already over capacity leaving San Jose.
	6/30/2015 8:09:05	06/30	1	Palo Alto	North	7:05 am	323	Bombardier	

Total unique 199

## Caltrain leaves customers with bicycles behind

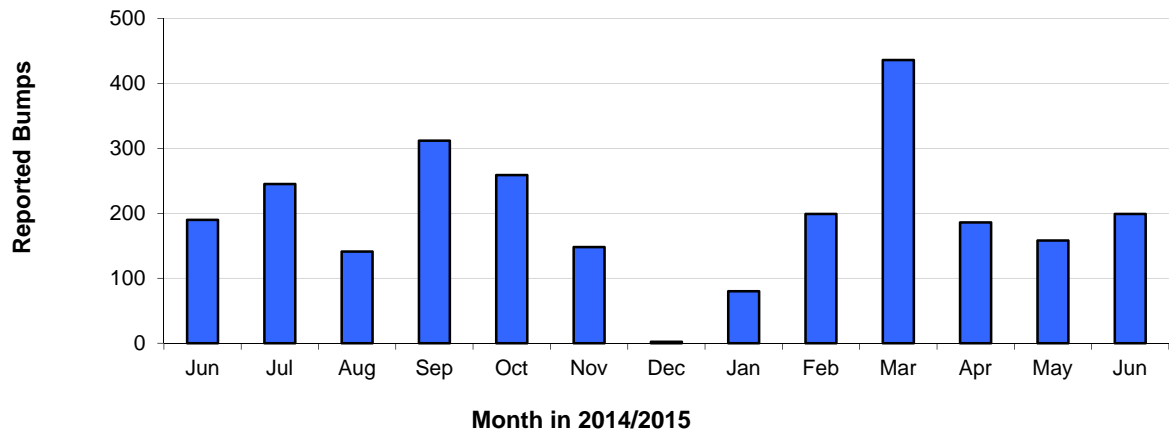

Not all bumps are reported, so actual bumps are more than shown.

## McKenna, Nancy

---

**From:** Roland Lebrun <ccss@msn.com>  
**Sent:** Wednesday, July 01, 2015 8:40 AM  
**To:** Board (@caltrain.com)  
**Cc:** SFCTA Board Secretary; VTA Board Secretary; info@mtc.ca.gov; cacsecretary (@caltrain.com); SFCTA CAC; Caltrain, Bac (@caltrain.com)  
**Subject:** Caltrain Board Item #9 EMU Procurement RFP  
**Attachments:** Caltrain July 2105 Board Item #9 EMU procurement.pdf; Alternate Caltrain EMU specification proposal.pdf

Dear Chair Tissier and Members of the Caltrain Board of Directors,

Please find attached my comments highlighting multiple issues with the issuance of the Caltrain EMU RFP as follows:

- Apparent disregard for off-the-shelf solutions for mixed platform heights with the potential to save \$65M in EMU Procurement Consultant fees.
- No mention of DMU hybrids (EDMUs) resulting in the requirement to store new trains for 2-3 years while waiting for the completion of the Caltrain electrification.
- No specification for density requirement for seats, wheelchairs, bicycles etc. (e.g. 900 seats & 100 bicycles within a 700-foot platform).
- Inadequate number of bathrooms.
- Inadequate funding plan and lack of request for financing proposals in the RFP.

Sincerely,

Roland Lebrun.

cc

SFCTA Board of Directors  
VTA Board of Directors  
Metropolitan Transport Commission  
Caltrain CAC  
Caltrain BAC  
SFCTA CAC

Roland Lebrun  
[ccss@msn.com](mailto:ccss@msn.com)  
July 2015 Board Meeting  
Item #9 EMU RFP

Dear Chair Tissier and Members of the Caltrain Board Directors,

Further to my letter of April 26<sup>th</sup> (attached), I am writing to express serious concerns about the Caltrain EMU Request For Proposals (RFP) as drafted by SamTrans staff and consultants.

1) Staff inexplicably ignored the option of an articulated EMU design with separate single-level motorized modules consisting of a dual set of level-boarding doors, toilets and wheelchair and/or bicycle accommodation, including a solution whereby **additional modules could be ordered off-the-shelf with a 50" boarding height at a later date and alternated with 25" modules in the unlikely event of a requirement to accommodate dual platform heights.**



2) **Staff refused to consider an EDMU (hybrid) option** which would have allowed testing and commissioning upon delivery starting in winter 2018 instead of having to store new EMUs for up to 3 years until electrification is complete in 2021.

3) Staff are recommending a 9 to 1 seat to bicycle ratio but **the RFP completely lacks any specification for seats/bikes/wheelchairs per foot of platform.** As an example, the train configuration in the attached letter is capable of carrying 900 seated passengers and 100 bicycles within 660 feet.

4) The current bathroom capacity on 5-car Gallery train sets (one ADA, one non-ADA) has proved to be wholly inadequate on a number of occasions. In contrast, 1<sup>st</sup> class High Speed coaches have 2 bathrooms so that if one is occupied, first class passengers have access to a spare 1<sup>st</sup> class bathroom and do not have to use a bathroom in 2<sup>nd</sup> class.

**Staff's recommendation to have a single bathroom on trains which are expected to have 50% more passenger capacity than the existing 6-bathroom Bombardier trainsets is despicable and I urge the Board to give direction to staff to adhere to a civilized country's bathroom ratio of approximately 1 bathroom for every 150 passenger seats.**

On a related note, it should be noted from the diagrams on the previous page that **a properly designed ADA bathroom occupies the same amount of space as 4 seats, not 8** as claimed on page 3 of the staff memo.

## 5) Funding

Caltrain initially had \$440M in FTA funding for replacement rolling stock.

This was subsequently reduced by \$125M to pay for electrification leaving \$315M for EMUs:

<http://www.caltrain.com/Assets/Caltrain+Modernization+Program/Documents/Bay+Area+HSR+Early+Investment+MOU+-+JPB+Board+Resolution+2012.pdf> (note 5 on page 9).

This amount was subsequently reduced by a further \$42.3M allocated to the EMU Procurement Consultant contract awarded to the firm LTK Engineering Services who were the sole bidder for a contract whose RFP they allegedly drafted themselves:

<http://www.caltrain.com/Assets/Agendas+and+Minutes/JPB/Board+of+Directors/Agendas/2014/3-6-14+JPB+Agenda.pdf> Item #13. This EMU Procurement contract award was subsequently increased to \$65M during the PCEP "cost/schedule update" on November 6<sup>th</sup> 2014 **leaving \$250M or less than half the amount required for new trainsets.**

<http://www.caltrain.com/Assets/Agendas+and+Minutes/JPB/Board+of+Directors/Presentations/2014/11-6-14+JPB+BOD+CalMod+Cost+and+Schedule+Update.pdf> slide 27.

### **Recommendation:**

Staff should either return to the Board with a full funding plan for the EMUs or add a request for financing proposals to the RFP, including availability payments instead of outright purchase.

Sincerely,

Roland Lebrun.

Cc

SFCTA Board of Directors  
VTA Board of Directors  
Metropolitan Transportation Commission  
Caltrain CAC  
SFCTA CAC

## Alternate Caltrain EMU specification proposal

### Background

The intent of this presentation is to introduce an alternative to SamTrans' proposal for dual-height Caltrain EMUs with two sets of doors and the **potential loss of over 200 seats per train**.

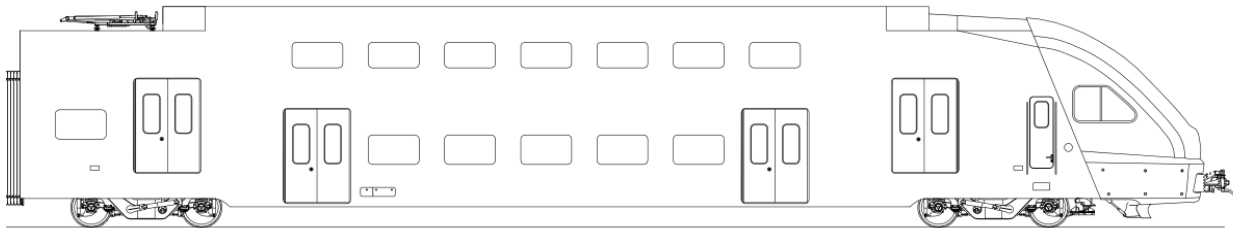

### Objectives

- Increase current seated/standing capacity and number of wheelchairs and ADA toilets by >50%
- Maintain existing bike capacity (80 bikes)
- **Limit train length to current platform standard (700 feet)**
- Enable boarding from existing platform height (8 inches) and future level boarding (22-24 inches)
- Compatibility with existing Caltrain infrastructure (tracks & tunnels) and fleet (25-inch boarding height)
- **Off-the shelf specification** capable of delivering trains by 2018
- **Capability to extend operating range beyond electrified territory** (hybrid power)
- **US manufacturing capability**

### Deliverable

A revised train specification for the consideration of the Caltrain Board of Directors as follows:

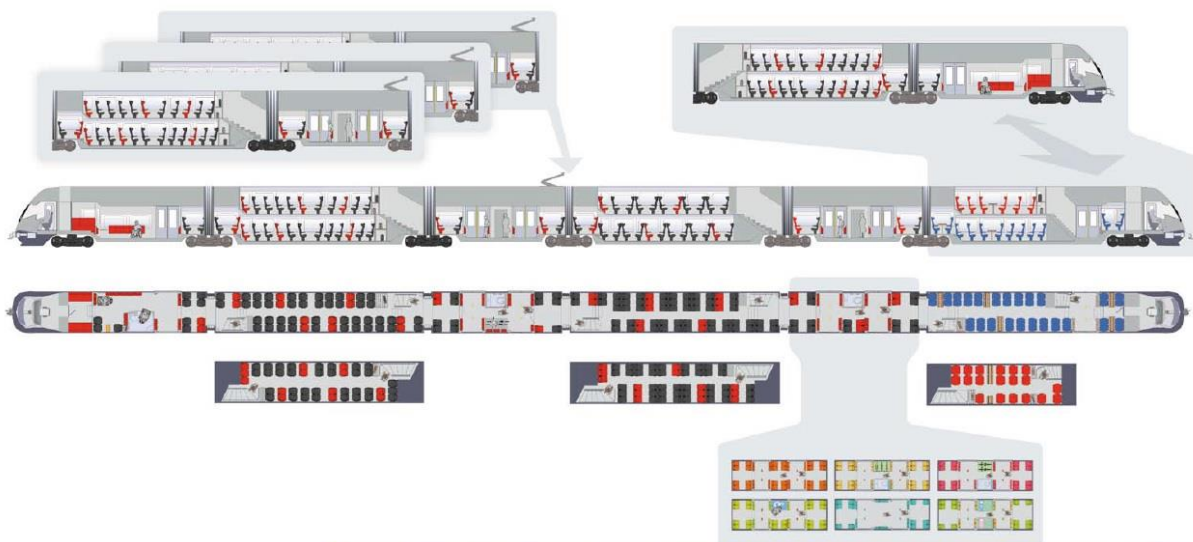



1) Off the shelf capacity

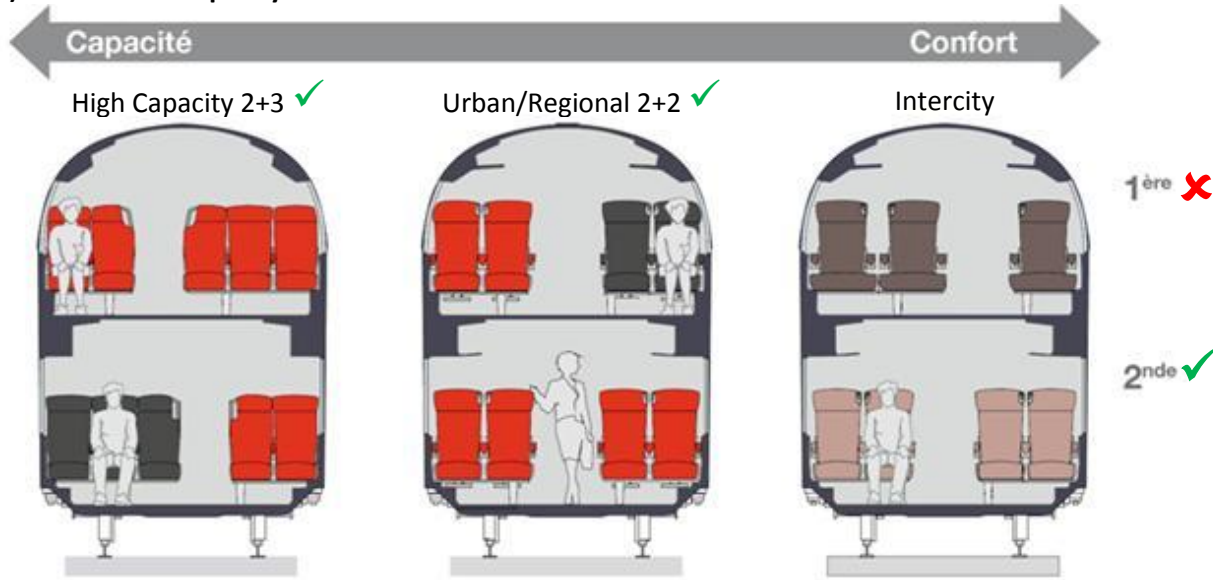

Length
271 feet
312 feet
361 feet

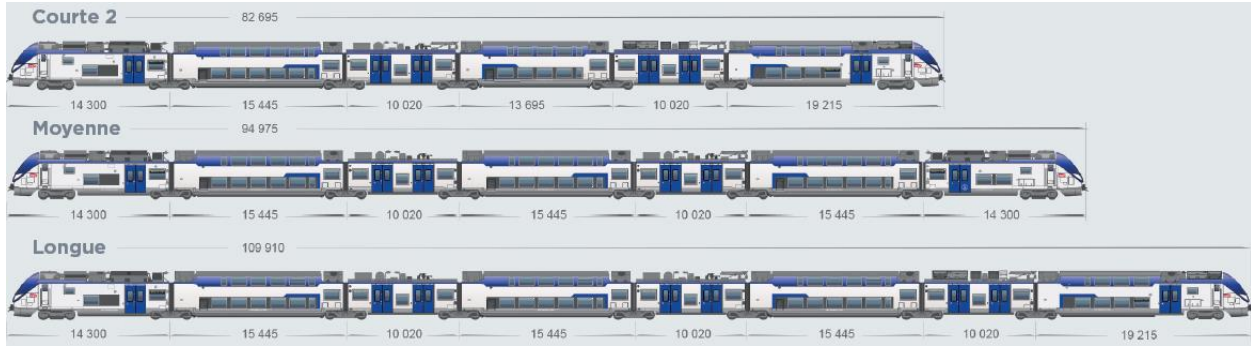

High Capacity 2+3	
Seats	Total
400-420	690-720
485-505	810-840
580-600	975-1005

Length
271 feet
312 feet
361 feet

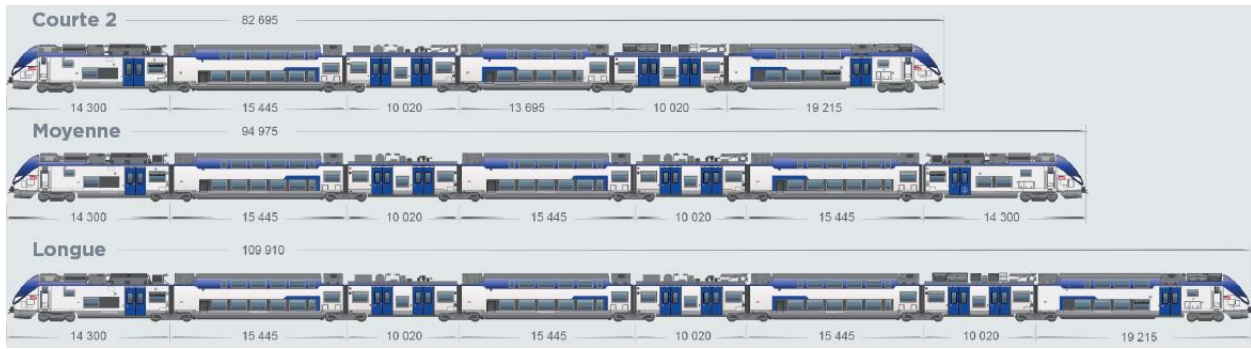

Urban/Regional 2+2	
Seats	Total
350-365	660-690
425-440	780-810
505-520	930-960

## 2) Front and rear bi-level cab cars

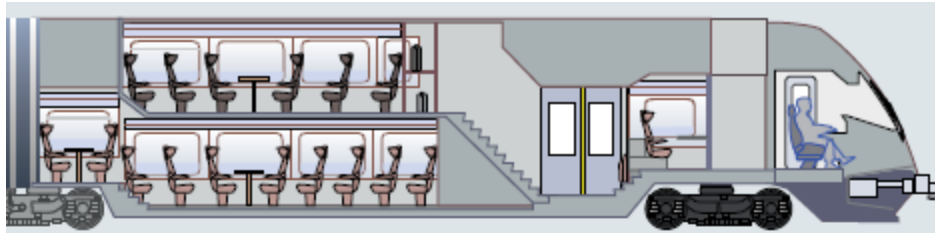

Powered Bogie

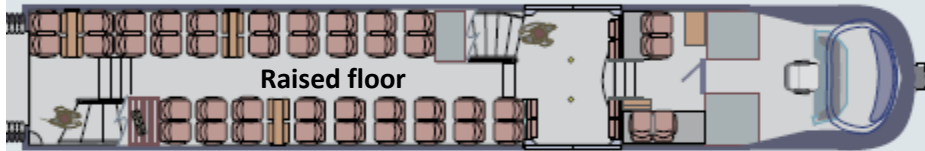

Raised floor

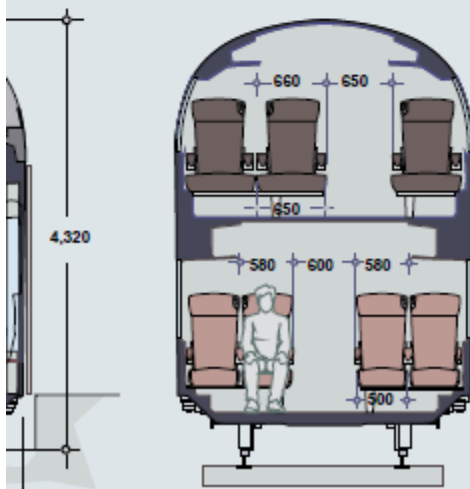

### MITRAC Hybrid Components

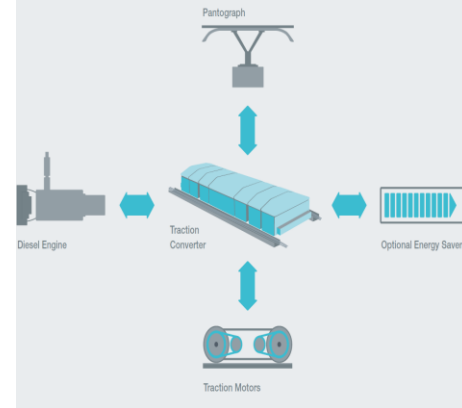

#### Lower deck modifications

- Remove 34 seats (for bikes)
- 8 seats (2+2) behind driver's cab
- Remove front stairs to upper deck
- Add two (total 8) flip-up seats
- Remove luggage rack
- Raise floor (eliminate step)

#### Modified lower deck capacity

- 40 bikes
- 12 seats (2+2 configuration)
- 8 flip-ups

#### Upper deck modifications

- Remove front stairs to upper deck
- 2+2 seating
- Remove luggage rack
- Remove tables

#### Modified upper deck capacity

- 38 seats (2+2 configuration)
- 1 middle front bulkhead seat

### 3) Single level motor cars

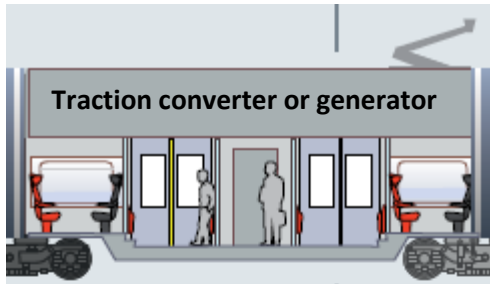

Powered Bogie



Wheelchair

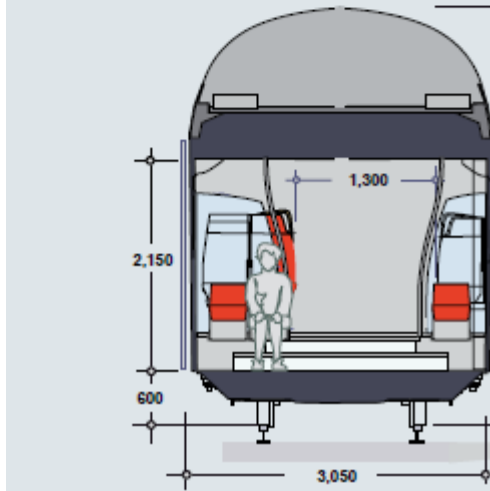

#### MITRAC Hybrid Components

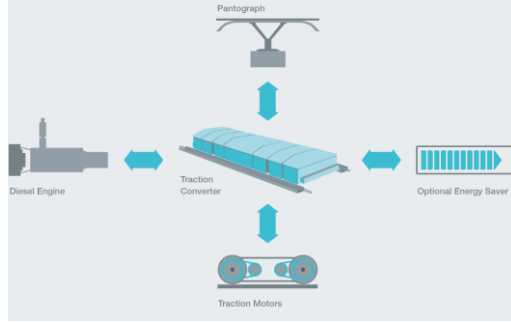

16 seats (2+2 configuration)

17 tip-ups

1 wheelchair

1 toilet

Six interior layouts



Roof-mounted traction converter

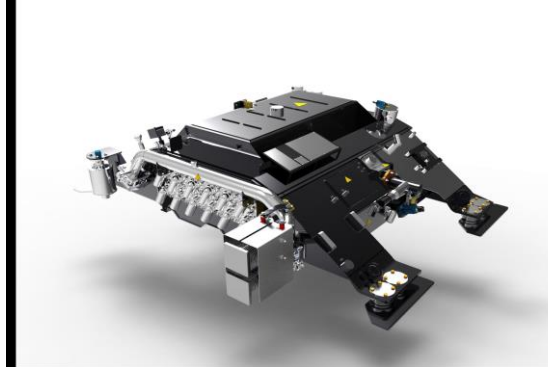

Hybrid powerpack

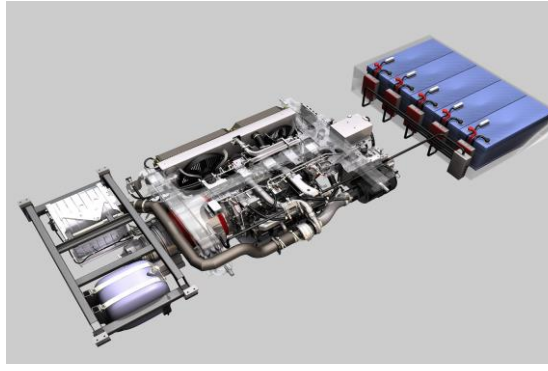

#### 4) Passenger cars



Powered Bogie

Lower deck



Upper deck



**No change** in off-the shelf 2+2 configuration

- 56 seats on the lower deck

- 46 seats on the upper deck

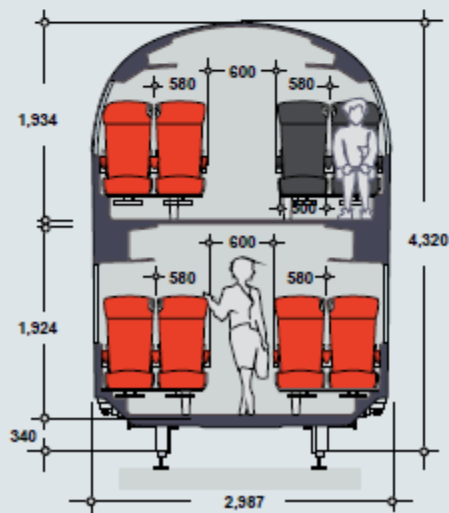

## Summary

Vehicle type	Length	# Seats	# Bicycles	# Toilets	# Wheelchairs	Power (MW)	Hybrid (MW)	Notes
Cab car	63.04	59	40			0.8		
Single deck	32.87	33		1	1			Converter
Double deck	50.67	102						
Single deck	32.87	33		1	1	0.8	0.7	Powerpack
Double deck	50.67	102						
Single deck	32.87	33		1	1		0.7	Powerpack
Double deck	50.67	102						
Single deck	32.87	33		1	1	0.8	0.7	Powerpack
Double deck	50.67	102						
Single deck	32.87	33		1	1		0.7	Powerpack
Double deck	50.67	102						
Single deck	32.87	33		1	1	0.8	0.7	Powerpack
Double deck	50.67	102						
Single deck	32.87	33		1	1		0.7	Powerpack
Cab car	63.04	59	40			0.8		
<b>Total</b>	<b>660.19</b>	<b>961</b>	<b>80</b>	<b>7</b>	<b>7</b>	<b>4</b>	<b>4.2</b>	

## Recommendation

The Caltrain Board of directors should consider an alternative EMU specification that includes:

- **No infrastructure modifications (existing tunnels, tracks and platform lengths & heights)**
- **Minimum 950 seats, 80 bicycles, 6 toilets and 6 wheelchairs**
- **Hybrid capability** (Facebook, Gilroy and Great America extensions)

## McKenna, Nancy

---

**From:** Tracy Corral <TCorral@CycleCalifornia.com>  
**Sent:** Wednesday, July 01, 2015 8:34 AM  
**To:** Board (@caltrain.com)  
**Cc:** bikesonboard@sfbike.org; Nabong, Sarah; Murphy, Seamus; cacsecretary (@caltrain.com); Caltrain, Bac (@caltrain.com)  
**Subject:** Bike capacity on Caltrain

Dear People,

I'm writing to ask that you seriously consider increasing bicycle capacity for the trains when Caltrain moves forward with its electrification plan. My understanding is that staff has recommended no increase in bicycle capacity for these future trains. This is a short-sighted approach that has passengers in a bind and it's not going to get any better with electrification. Or worse, people will just drive to work. People want and need to use their bikes and ride Caltrain, but owing to the popularity of bringing a bike on the train, they can't.

Wayside bike parking doesn't cut it: While some people may be able to park their bikes at the station, many others have a long distance to ride to get to work from their destination train station. The bus systems are inadequate (many lines don't go where the jobs are located, as you probably already know) and walking from a station to work is out of the question.

Therefore, I ask respectfully that you consider an increase in bicycle capacity going forward.

Regards,

Tracy Corral

--

Tracy L. Corral  
Publisher/Editor  
Cycle California! Magazine  
1702-L Meridian Avenue, #289  
San Jose, CA 95125  
408/924-0270 fax: 408/292-3005  
[tcorral@cyclecalifornia.com](mailto:tcorral@cyclecalifornia.com)  
Find us on Facebook! [www.facebook.com/CycleCaliforniaMagazine](http://www.facebook.com/CycleCaliforniaMagazine)

## McKenna, Nancy

---

**From:** Rick Girling <rzgirling@gmail.com>  
**Sent:** Wednesday, July 01, 2015 8:30 AM  
**To:** Board (@caltrain.com); cacsecretary (@caltrain.com); Caltrain, Bac (@caltrain.com)  
**Cc:** Janice Li; bikesonboard@sfbike.org  
**Subject:** bikes on Caltrain

Bicycles were one of the first mechanical means of transportation. Trains were main means of long distance transportation of the past. Together they can be a powerful means of future transportation that use minimal amounts of carbon based fuels, contribute to healthier and quieter communities. Please work for the future by updating your trains and expanding opportunities for bicycle commuting in an increasingly crowded urban area.

Sincerely,  
Richard Girling  
182 Banks St.  
SF CA 94110

**McKenna, Nancy**

---

**From:** pete slosberg <pete.slosberg@gmail.com>  
**Sent:** Wednesday, July 01, 2015 8:11 AM  
**To:** Board (@caltrain.com); cacsecretary (@caltrain.com); Caltrain, Bac (@caltrain.com)  
**Cc:** janice@sfbike.org; bikesonboard@sfbike.org  
**Subject:** I Support More Bike Space On Board and More Bike Parking for Caltrain

Please, please, please make Caltrain more bicycle friendly. It would certainly influence my decision to forego driving to the Peninsula and take my bike on Caltrain instead

Pete Slosberg



## McKenna, Nancy

---

**From:** Joshua Cantor <josh.s.cantor@gmail.com>  
**Sent:** Wednesday, July 01, 2015 7:11 AM  
**To:** Board (@caltrain.com); cacsecretary (@caltrain.com); Caltrain, Bac (@caltrain.com)  
**Cc:** janice@sfbike.org; bikesonboard@sfbike.org  
**Subject:** I Support More Bike Space On Board and More Bike Parking for Caltrain

To Caltrain Joint Powers Board of Directors:

On July 2, there is an important opportunity to shape the future of Caltrain, and I would like to advocate for a number of important points:

- I urge you to pass a design that provides bike capacity for at least 16 percent of Caltrain passengers;
- I urge you to make it an official goal that at least 20 percent of Caltrain passengers will access the system by bike by 2020

As a rider of Caltrain and a cyclist, I strongly encourage you to invest in a system that encourages and supports cycling as a safe, low cost means of transportation throughout the Bay Area, and I believe these steps will go a long way in accomplishing both goals. To that end, thank you for recommending a significant \$3 million investment in secure bike parking and encourage, and please approve this recommendation on July 2.

Warmly,

Josh Cantor

## McKenna, Nancy

---

**From:** Joanneke Verschuur <integrityrenovations@hotmail.com>  
**Sent:** Wednesday, July 01, 2015 6:22 AM  
**To:** Board (@caltrain.com); cacsecretary (@caltrain.com); Caltrain, Bac (@caltrain.com)  
**Cc:** janice@sfbike.org; bikesonboard@sfbike.org  
**Subject:** I Support More Bike Space On Board and More Bike Parking for Caltrain

20% bikes!! It only makes sense.

Thank you,

Joanneke Verschuur

**McKenna, Nancy**

---

**From:** Bikes on Board <bikesonboard@sfbike.org>  
**Sent:** Wednesday, July 01, 2015 12:56 AM  
**To:** Board (@caltrain.com); cacsecretary (@caltrain.com); Caltrain, Bac (@caltrain.com)  
**Cc:** Janice Li; bikesmc@hotmail.com; emma@bikesiliconvalley.org  
**Subject:** Recommendations for Bicycle Usage with Electrified Caltrain  
**Attachments:** Recommendations\_for\_Bicycle\_Usage\_with\_Electrified\_Caltrain\_20150630.pdf

Dear Chair Tissier and Members of the Joint Power Board,

Please see the attached document titled "Recommendations for Bicycle Usage with Electrified Caltrain."

Respectfully submitted,  
BIKES ONboard Team

# Recommendations for Bicycle Usage with Electrified Caltrain

June 30, 2015

Prepared by:  
BIKES ONboard Project

## Executive Summary

We recommend that Caltrain strive to shift mode share for station access from motorized transportation to bicycling to take advantage of the many economic, environmental, and social benefits of bicycling. Caltrain should set a goal of 32% bicycle mode share by 2020, with 16% of passengers bringing a bike onboard and 16% of passengers parking a bike at the station.

To accommodate future ridership and achieve the service standard policy of 1.2 load factor, Caltrain needs to run longer electrified trains. We encourage Caltrain to identify funding to purchase additional electric multiple units (EMUs) and extend platform length.

EMUs should be designed with a 5:1 ratio of seats to bikes to accommodate 16% of passengers bringing a bike onboard at a load factor of 1.2. We further recommend equal bike capacity in all EMUs and level boarding for operational efficiency.

# Table of Contents

<b>EXECUTIVE SUMMARY .....</b>	<b>2</b>
<b>1 INTRODUCTION.....</b>	<b>4</b>
1.1 PURPOSE OF THIS DOCUMENT.....	4
1.2 BENEFITS OF BICYCLE USAGE WITH CALTRAIN .....	4
1.3 BICYCLING IMPROVES STATION ACCESS.....	5
1.4 BICYCLE COMMUTING IS ON THE RISE .....	5
<b>2 RESULTS OF SURVEYS OF CALTRAIN PASSENGERS.....</b>	<b>6</b>
2.1 SURVEY OF BIKE PARKING CUSTOMERS.....	6
2.2 REASONS PASSENGERS BRING THEIR BIKES ONBOARD.....	7
2.3 ALTERNATIVES TO BRINGING A BIKE ONBOARD .....	8
<b>3 BIKE PARKING AT STATIONS.....</b>	<b>9</b>
3.1 ESTIMATED PERCENTAGE OF PASSENGERS PARKING BIKES AT STATIONS .....	9
3.2 TYPES OF BIKE PARKING OPTIONS .....	9
3.3 ANALYSIS OF PALO ALTO BICYCLE PARKING FACILITY USAGE .....	9
3.4 ANALYSIS OF SAN FRANCISCO BICYCLE PARKING FACILITY USAGE.....	11
3.5 BIKE PARKING AT BART STATIONS FOR COMPARISON.....	13
3.6 BIKE LOCKERS .....	14
3.7 BIKE SHARE .....	14
<b>4 BIKES ONBOARD.....</b>	<b>15</b>
4.1 HISTORY OF INCREASING BIKE CAPACITY ONBOARD CALTRAIN.....	15
4.2 THE EFFECT OF BUMPING CUSTOMERS WITH BICYCLES .....	16
4.2.1 <i>Historical bump reports</i> .....	16
4.2.2 <i>Caltrain bump counts</i> .....	17
4.2.3 <i>Bumps cost Caltrain ridership and revenue</i> .....	17
4.3 INCREASES IN BIKE BOARDINGS OUTPACE WALK-ON BOARDINGS.....	18
4.4 FUTURE PROJECTED BIKE BOARDINGS .....	20
<b>5 GOALS FOR BIKE PARKING AND BIKES ONBOARD IN 2020 .....</b>	<b>20</b>
<b>6 ELECTRIC MULTIPLE UNIT DESIGN.....</b>	<b>22</b>
6.1 SPACE ALLOCATION FOR SEATS/STANDEES/BIKES .....	22
6.2 CALTRAIN NEEDS TO RUN LONGER ELECTRIFIED TRAINS.....	23
6.3 LEVEL BOARDING .....	24
6.4 BIKE SPACE IN ALL CARS IMPROVES OPERATIONS .....	24
<b>7 SUMMARY OF RECOMMENDATIONS.....</b>	<b>24</b>
<b>8 APPENDICES.....</b>	<b>25</b>

# 1 Introduction

## 1.1 Purpose of this document

Caltrain, the commuter rail line serving the San Francisco Peninsula, plans to electrify its line in 2020 and will purchase new rail cars, known as electric multiple units (EMUs). The purpose of this document is to help Caltrain plan for electrified service by providing predictions of the percentage of passengers using a bicycle with electrified Caltrain. This document offers recommendations for bikes parking at stations and for bikes onboard EMUs.

## 1.2 Benefits of bicycle usage with Caltrain

Some of the many benefits of using a bicycle with Caltrain are summarized below:

1. Biking to Caltrain stations is more cost-effective than all station-access modes except walking.<sup>1</sup>
2. Bikes onboard increase ridership. Eighty percent of passengers who bring a bike onboard said they seldom or never ride Caltrain, if they can't bring their bikes onboard.<sup>2</sup>
3. Bikes onboard allow passengers to reach the station and their final destination without using motorized transportation on either end of their commutes, thereby reducing carbon emissions. California has mandates to reduce carbon emissions, a leading cause of climate change.
4. Biking to and from Caltrain stations frees up seats on shuttles and feeder buses, many of which are crowded.
5. Biking to and from Caltrain stations reduces the need for new shuttles and buses.
6. Bikes onboard reduce traffic congestion, which shortens driving time for commuters who drive, thereby reducing pollution and stress.
7. Biking to Caltrain stations reduces the need for parking spaces at stations, so drivers will be able to find a parking space more easily.
8. Biking to Caltrain stations reduces demand for new parking lots or parking structures. Impermeable surfaces of parking lots damage the environment by sealing the soil surface, preventing rain water infiltration and depriving tree roots of aeration. Furthermore, many Caltrain parking lots are in quaint downtown areas where real estate is at a premium, and the land could be put to more productive use. The only way to increase parking at most stations would be to build multi-level parking structures at a cost of over \$30,000 per parking space, and an unsightly parking garage would not be welcomed by most local residents.
9. Biking to stations allows passengers to avoid short automobile trips, which cause excessive pollution due to pollution control devices not reaching optimal operating temperature.

---

<sup>1</sup> Plan for Bicycle Carriage on Caltrain, San Francisco Bicycle Coalition, BIKES ONboard Project, December 2008, p. 19.

<sup>2</sup> 2007 Caltrain Online Bicycle Survey: Selected Preliminary Results, reported in the agenda for the July 11, 2007 meeting of the Caltrain Bicycle Master Plan Technical Advisory Group. Caltrain conducted the Online Bicycle Survey from May 21 to June 1, 2007. The number of respondents was 1571 including 1180 bike+Caltrain users, 169 former users, and 222 potential users.

10. Biking to and from Caltrain stations enables commuters to get exercise, improving their overall health and well-being, while at the same time not contributing to air pollution. Less pollution and more exercise means healthier people, saving health care costs.

### 1.3 *Bicycling improves station access*

Caltrain provides an essential transit service, but that service is rarely door-to-door. Commuters must find a way to get to the station from their starting points and reach their destinations after exiting the train. Public transportation, even when available, does not provide 100% coverage.

Proximity to transit is an important consideration. In the Bay Area, people who live within a half-mile radius of a transit station are three times more likely to use transit compared with those who live farther away.<sup>3</sup> The average person can walk half a mile in about 10 minutes. In that same time, the average bicyclist can cover about two miles, increasing the number of people within easy reach of a Caltrain station by 16-fold, as illustrated in Figure 1. The combination of bicycles and Caltrain represents a practical and environmentally friendly intermodal transportation solution.

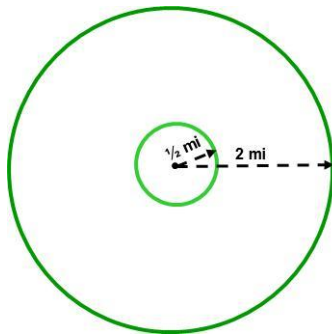

**Figure 1.** In 10 minutes, the average person can walk ½ mile or bicycle two miles. The concentric circles, with the station at the center point, illustrate that bicycling brings 16 times more people within 10 minutes of a Caltrain station.

### 1.4 *Bicycle commuting is on the rise*

The San Francisco Municipal Transportation Agency conducts annual bicycle counts at many intersections in San Francisco. The counts show that bicycle ridership has doubled between 2006 and 2013.<sup>4</sup> The increase is approximately linear as shown in Figure 2, and one would expect this trend to continue, especially considering the rapid and continuing improvements to bicycle facilities on San Francisco streets, as well as throughout the Bay Area.

<sup>3</sup> Metropolitan Transportation Commission's Resolution 3434, Transit-Oriented Development Policy, July, 2006.

<sup>4</sup> SF MTA 2013 Bicycle Count, San Francisco Municipal Transportation Agency, December 2013, p 4.



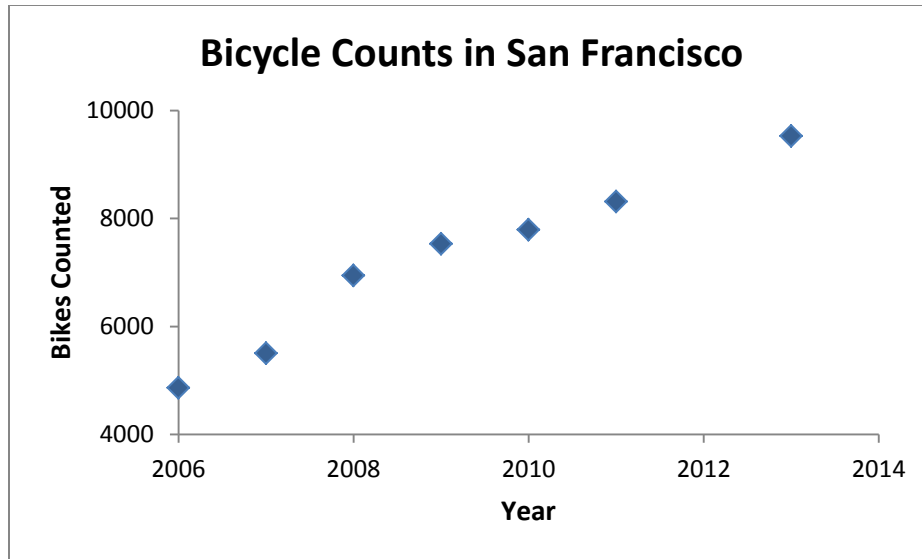

**Figure 2.** Annual bicycle counts in the city of San Francisco show bicycling has doubled from 2006 to 2013.

## 2 Results of Surveys of Caltrain Passengers

### 2.1 Survey of bike parking customers

Warm Planet Bikes, the former operator of the bike parking facility at the 4<sup>th</sup> & King Caltrain station, conducted a web-based survey of its bike parking customers in June 2008.<sup>5</sup> Of particular interest is how Caltrain passengers accessed the station before they started parking at Warm Planet Bikes. The relevant survey question and responses are shown below:

**How did you usually reach Caltrain before parking your bike at Warm Planet Bikes?**

Walked to Caltrain	5.70%
Took public transportation to Caltrain	21.40%
By car to Caltrain	12.90%
Rode my bicycle and parked it at the station	25.70%
Rode my bicycle and took it on board Caltrain	27.10%
Did not go to Caltrain before	7.10%

The survey results demonstrate the large benefit of providing safe and secure bike parking. Bike parking not only brought new customers to Caltrain, but also reduced automobile trips and freed seats on public transportation. Twenty-seven percent of bike parking customers formerly brought their bikes onboard the train, so secure bike parking can help alleviate overcrowding in bike cars.

The survey also queried customers about trip length, with results shown in Figure 3. Most people biked three miles to reach the bike parking facility, though just as many biked even farther. The survey responses are consistent with studies that show that bicycle commuters will bike an

<sup>5</sup> Warm Planet Bikes Parking Facility Report for the First Full Year of Operation, June 30, 2007 – June 30, 2008, Warm Planet Bikes, July 2008, p. 7.

average of three miles one-way.<sup>6</sup> This emphasizes that bicycling greatly expands station access compared with walking.

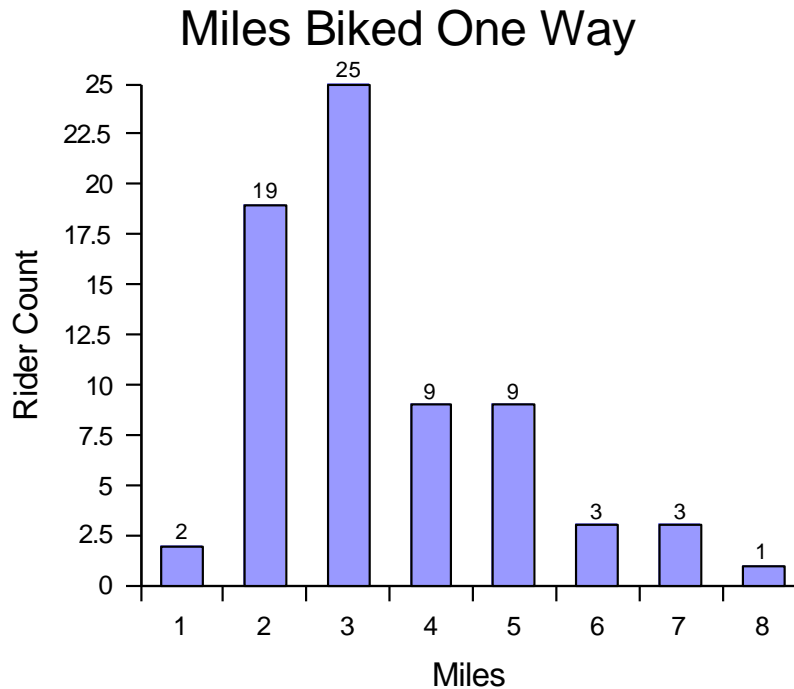

**Figure 3.** Results from an online survey Warm Planet Bikes conducted of its bike parking customers in 2008. The histogram shows responses to the question, “How many miles do you usually ride your bicycle for your daily commute one-way?”

## 2.2 Reasons passengers bring their bikes onboard

Bike carriage on trains is a critical element for a complete transportation solution. Many bicyclists need their bicycles at both ends of their commutes, because their starting points and final destinations are not near the train stations. Bicycle commuters need their bicycles to complete their intermodal trips, because public transportation is either nonexistent, or riding a bicycle is faster and/or more reliable than the available public transportation.

Caltrain conducted an online survey of bicycle commuters in 2007<sup>7</sup> to ascertain reasons passengers bring bikes onboard.

The top four reasons passengers cited for bringing a bike on board include:

Having my bike with me gives me flexibility	58%
I need to have my bike with me	37%
I bike the other way for exercise	32%
Transit/shuttle connections don't work for me	31%

<sup>6</sup> Osborn, Lynn, “TDM Cost Effectiveness, How VMT Reduction Translates to Congestion Mitigation and Improved Air Quality”, ACT International Conference, TDM Cost Effectiveness White Paper, 2003, p.7.

<sup>7</sup> 2007 Caltrain Online Bicycle Survey, *Op. cit.*

About 40% of cyclists vary their normal commute by sometimes starting or ending at a different station, a commute pattern that would be impossible if they had a bicycle parked at each end of their normal commute. The flexibility of having a bicycle with them allows irregular trip chaining, such as running an off-line errand on the way home or attending an engagement after work located by a different station than the normal destination station.

Today’s train schedule results in some stations with infrequent service, but a bicycle enables a cyclist to use various stations. For example, train service to Belmont is once per hour. A cyclist traveling from San Francisco 4th & King to Belmont could exit at Belmont, but also at Hillsdale, San Carlos, or Redwood City and easily ride to Belmont. By adding the other exit stations for a morning commute, the bicyclist can board any of ten trains between 7am and 9am instead of only two trains. Such flexibility would be impossible without being able to bring one’s bike on board the train. It is particularly important to be able to bring bikes on board trains for destinations on the Peninsula, where public transport options can be limited and infrequent.

Over 60% of bicycle commuters ride their bikes to and from Caltrain to be environmentally friendly. The ability to bring one’s bike on board the train permits a bike commuter to complete their daily travel requirements without using an automobile at all.

### 2.3 Alternatives to bringing a bike onboard

Caltrain conducted an online survey in 2014 to gather information to help inform design of EMUs.<sup>8</sup> The survey is statistically invalid, as it was an opt-in survey, not a random sample. For example, 44% of survey respondents brought their bikes onboard Caltrain, more than actually bring bikes onboard. Some of the survey questions related to bicycles are reproduced in Figure 4.

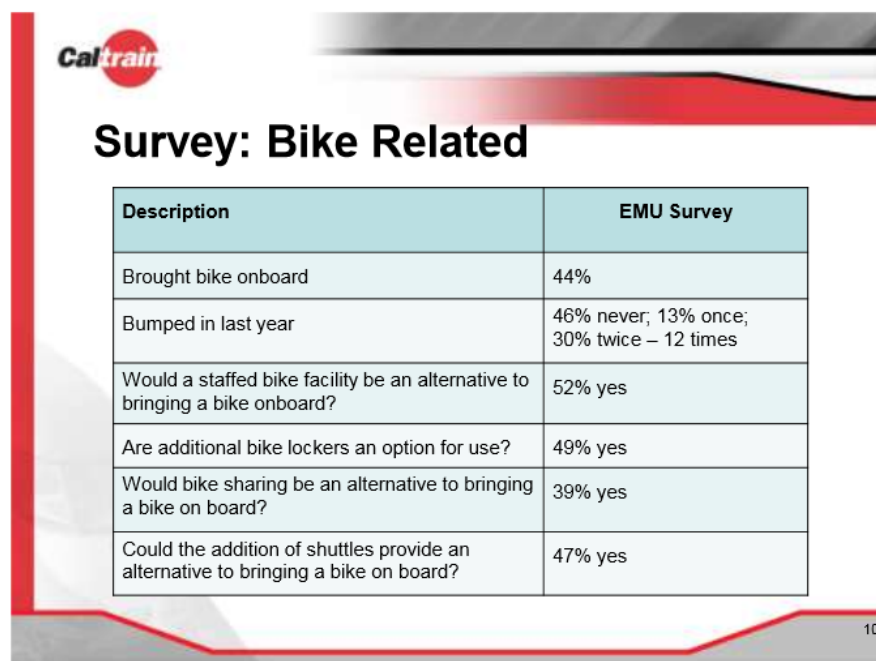

**Figure 4.** Results from an online survey Caltrain conducted in 2014.

<sup>8</sup> [http://www.caltrain.com/Assets/\\_Agendas+and+Minutes/JPB/Board+of+Directors/Presentations/2015/2015-02-05+JPB+BOD+PCEP+Qtrly+Update.pdf](http://www.caltrain.com/Assets/_Agendas+and+Minutes/JPB/Board+of+Directors/Presentations/2015/2015-02-05+JPB+BOD+PCEP+Qtrly+Update.pdf)

The survey asked questions about hypothetical alternatives to bringing a bike onboard, and about 50% of people said they would consider an alternative.

The online survey Caltrain conducted in 2007<sup>9</sup> asked more directly: “Why do/did you bring your bike onboard?” Only 20% said they brought their bikes onboard due to either unsatisfactory bike parking options (18%) or unaware of bike parking options (2%).

The survey results suggest some Caltrain customers may consider alternatives to bringing a bike onboard. This is highly desirable, as onboard space is limited.

### **3 Bike Parking at Stations**

#### **3.1 Estimated percentage of passengers parking bikes at stations**

Caltrain estimates that 1% of passengers park bikes at lockers, racks, or shared bicycle storage at or near stations.<sup>10</sup> This percentage has been approximately constant since 2008.<sup>11</sup> We present evidence, however, that with better bike parking facilities, more passengers would be willing to bike to the station and then park their bike at the station.

#### **3.2 Types of bike parking options**

There are a number of options for parking bikes at stations including racks, lockers, bike cages, and staffed facilities. The greater the level of security, the more popular the bike parking option is with bicyclists. Bike racks are the least secure and the least popular, whereas staffed bike parking facilities, being the most secure, have been very popular with bicycle commuters. We report two examples of staffed bike parking facilities from the Caltrain corridor, one at the Palo Alto University Avenue station and the second at the San Francisco 4<sup>th</sup> & King station.

#### **3.3 Analysis of Palo Alto bicycle parking facility usage**

The Palo Alto bicycle parking facility opened in April 1999 as a staffed bike parking facility in the station’s former baggage building. It was managed by a local bicycle shop, which provided valet bicycle parking at no charge. Bicycle repairs, rentals and retail sales were also offered at this facility. While the baggage building was undergoing repairs starting in 2003, the bicycle parking operations were suspended. When bike parking resumed in 2007, the facility was reborn as a self-service/automated Bikestation. Since that time, all users have been required to become Bikestation members and to pay for using the facility.<sup>12</sup>

Usage of the staffed bike parking facility rapidly increased after it opened in 1999, as shown in Figure 5.<sup>13</sup> Usage was quite high until the facility closed in 2003. Once re-opened in 2007, the self-service facility proved much less popular, with approximately half the usage compared with the previous staffed facility. This is particularly noteworthy, because bicycling has been on the

---

<sup>9</sup> 2007 Caltrain Online Bicycle Survey, *Op. cit.*

<sup>10</sup> Peninsula Corridor Electrification Project Final Environmental Impact Report, Peninsula Corridor Joint Powers Board, December 2014, p. 3.14-9.

<sup>11</sup> Caltrain Bicycle Access and Parking Plan, Peninsula Corridor Joint Powers Board, October 2008, p. 6.

<sup>12</sup> Caltrain Bicycle Access and Parking Plan, *Op. cit.*, p. 76.

<sup>13</sup> Bikestation Palo Alto Monthly Report, Mobis Transportation Alternatives, January 2012.

rise for years. One would have expected even greater usage after the three-year closure due to increased bicycling, but that was not the case.

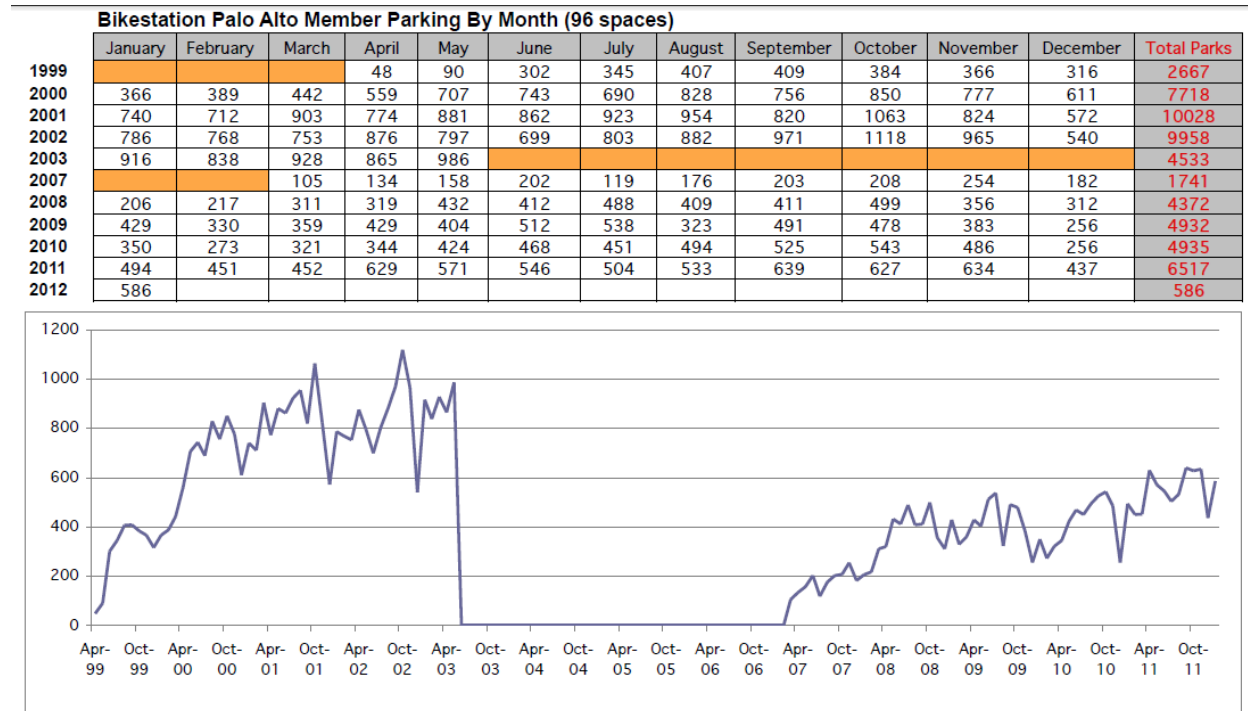

**Figure 5.** Historical bike parking at the bicycle parking facility at Palo Alto station shows the facility was much more popular when it offered free valet bike parking from 1999 to 2003 compared with when it became a member-based, self-service facility starting in 2007. The facility was closed from 2003 to 2007 for building repairs.

Table 1 shows that over 30% of those who biked to the Palo Alto station in the morning parked their bikes at bike parking facility when the facility was staffed, whereas less than 10% parked their bikes there when the facility was self-service. This demonstrates that bicyclists much prefer a staffed bicycle parking facility over a member-based, self-service facility.

Year	Type of bike parking	Weekday AM bike boardings at Palo Alto	Bikes parked in February	Bikes parked each weekday	Total number who biked to Palo Alto in AM each weekday	% of riders parking at Palo Alto Bikestation
2002	staffed valet	78	768	38	116	33.1%
2003	staffed valet	87	838	42	128	32.6%
2008	self-service	135	217	11	146	7.4%
2009	self-service	171	330	17	187	8.8%

**Table 1:** Bike boardings compared with bikes parked at the bicycle parking facility at the Palo Alto station in February of each year shown. Average weekday bike boardings at Palo Alto are taken from Caltrain February annual passenger counts, and we estimate that half of daily bike boardings occur in the morning (AM) and half in the evening. (Unlike walk-on boardings, bike boardings do not show a traditional peak and reverse peak direction, but are approximately evenly split.<sup>14</sup>) The data highlight the greater popularity of valet bike parking compared with self-service.

### 3.4 Analysis of San Francisco bicycle parking facility usage

The bike parking facility at the 4<sup>th</sup> & King Caltrain station was originally operated by Warm Planet Bikes to provide free valet bike parking service. The facility had a soft opening on June 30, 2007, and during the first six months, the number of users varied from month to month. The facility held a grand opening on January 9, 2008, and at that time started a marketing and publicity campaign. The number of users increased steadily each month after the grand opening, as shown in Figure 6.<sup>15</sup>

<sup>14</sup> Plan for Bicycle Carriage on Caltrain, San Francisco Bicycle Coalition, BIKES ONboard Project, December 2008, pp. 16-17.

<sup>15</sup> Warm Planet Bikes Parking Facility Report for the First Full Year of Operation, June 30, 2007 – June 30, 2008, Warm Planet Bikes, July 2008, p.7.

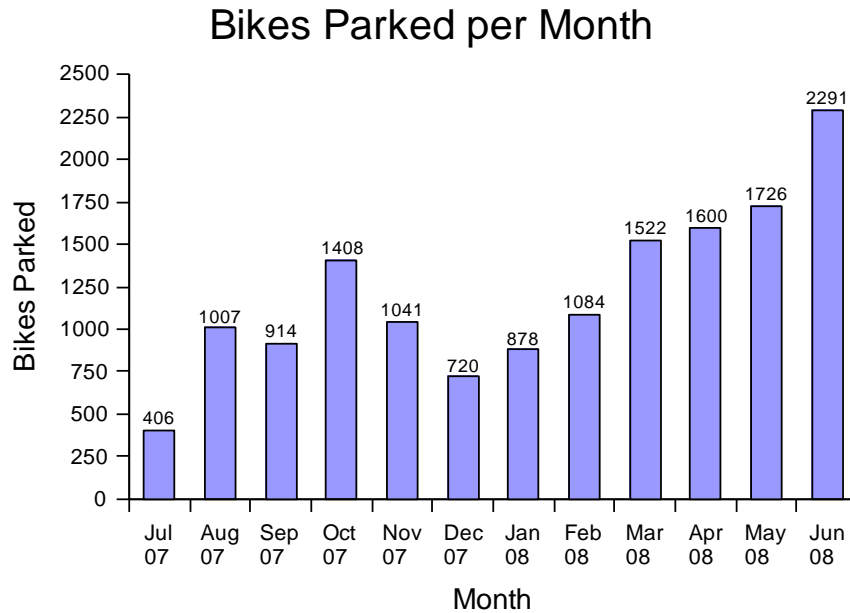

**Figure 6.** Historical bike parking at the bicycle parking facility at 4<sup>th</sup> & King station. The bike parking facility held a soft opening in July 2007 and a grand opening in January 2008.

Figure 7 shows that more bikes were parked at the facility every year until it ran out of space in 2011, at which time bike parking leveled off.<sup>16</sup> Warm Planet Bikes sacrificed retail space to be able to avoid turning bike parking customers away.

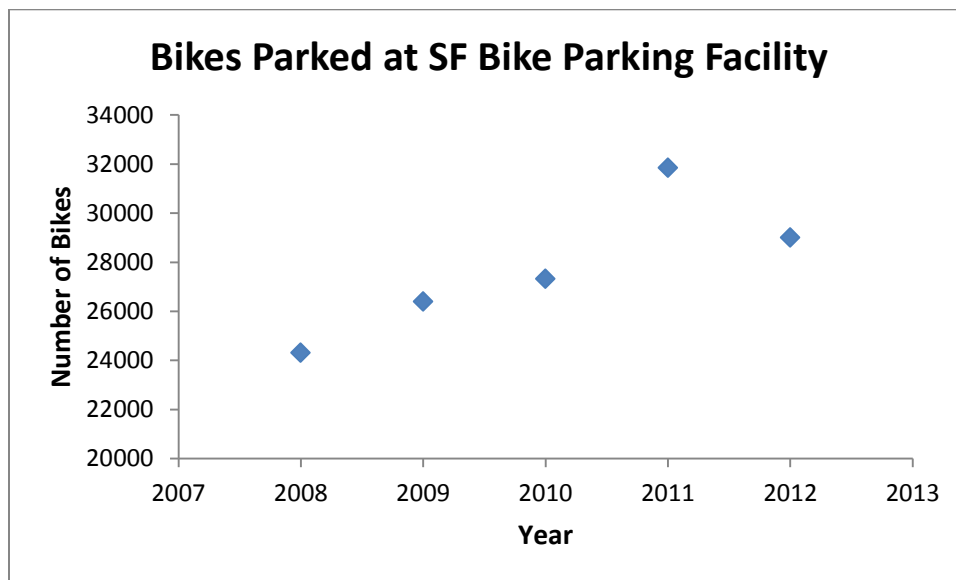

**Figure 7.** Historical number of bikes parking at bicycle parking facility at 4<sup>th</sup> & King. Number of bikes parked continued to climb until the facility reached capacity around 2011.

<sup>16</sup> Warm Planet Bikes Annual Reports, Warm Planet Bikes, 2008 – 2012.

Warm Planet Bikes operated the facility until 2013, when Alameda Bicycle took over operations. Alameda Bicycle is looking to expand the facility to accommodate growing demand.

Table 2 shows that approximately 20% of people who biked to the 4th & King station in the mornings parked their bikes at the staffed bike parking facility.

Year	Weekday AM bike boardings at 4 <sup>th</sup> & King	Bikes parked in February	Bikes parked each weekday	Total number who biked to 4 <sup>th</sup> & King in AM each weekday	% of riders parking at SF bike parking facility
2008	274	1084	54	328	16.5%
2009	325	1861	93	418	22.3%
2010	318	1857	93	410	22.6%
2011	448	2286	114	562	20.3%
2012	526	2242	112	638	17.6%
2013	583	2143	107	690	15.5%
2014	686	2690	135	820	16.4%
2015	721	3802	190	911	20.9%

**Table 2:** Bike boardings compared with bikes parked at 4<sup>th</sup> & King bike parking facility in February of each year shown.<sup>17,18</sup> Average weekday bike boardings at 4<sup>th</sup> & King are taken from Caltrain February annual passenger counts, and we estimate that half of daily bike boardings occur in the morning (AM) and half in the evening.

### 3.5 Bike parking at BART stations for comparison

For comparison purposes, we provide data for bicycles parked at bicycle parking facilities at BART stations in Figure 8.<sup>19</sup> Of particular interest is that more than twice as many people park their bikes at staffed valet bike parking at Berkeley and Fruitvale compared with self-service facilities, including at the same Berkeley location. This result is consistent with bike parking at Caltrain’s Palo Alto bicycle parking facility, which was used by about twice as many people when it was a staffed valet parking vs. self-service parking. The total number of bikes parked annually at BART stations continues to rise, a testament to the increasing popularity of bicycling.

<sup>17</sup> Warm Planet Bikes Annual Reports, Warm Planet Bikes, 2008 – 2013.

<sup>18</sup> Data for 2014 and 2015 kindly provided by Gene Ho, Alameda Bicycle.

<sup>19</sup> Year-end Report 2014, Bikestation, Alameda Bicycle, July 2014.



## Total Parked by Station

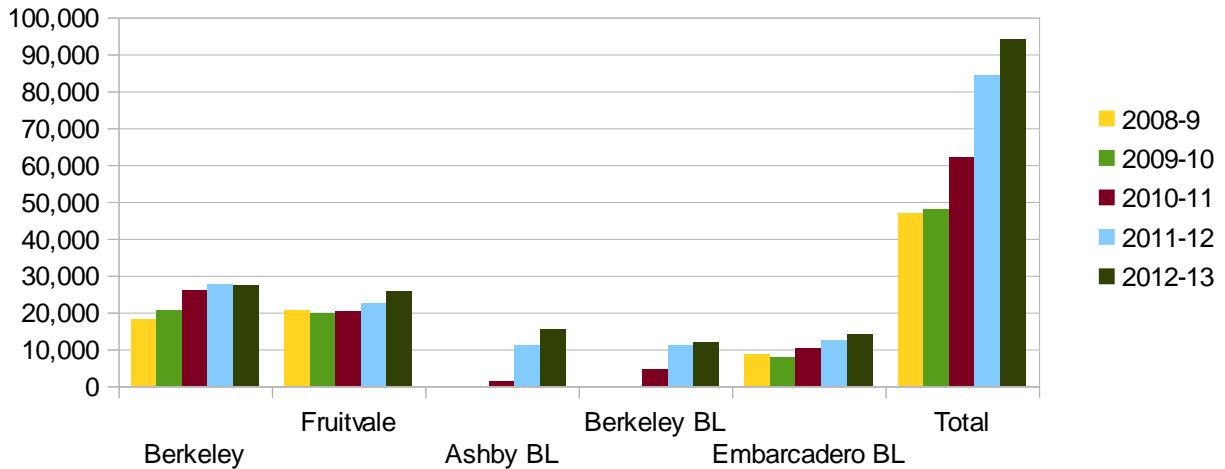

**Figure 8.** Number of bicycles parked annually at BART stations in staffed and self-service (BL) facilities. Consistent with the observation at Caltrain’s Palo Alto Bikestation, more than twice as many bikes are parked at a staffed valet parking facility compared with a self-service facility.

### 3.6 Bike lockers

Many Caltrain stations have keyed bike lockers, and their usage is undersubscribed. In February 2012, Caltrain staff surveyed bike locker utilization at Palo Alto and Mountain View, two of the top three busiest stations for bike boardings (4<sup>th</sup> & King is the busiest). Results were presented to the Caltrain Bicycle Advisory Committee, and are shown below:

#### *Bike Parking Utilization in February 2012*

Bike lockers in Palo Alto: 45.7% in use

Bike lockers in Mountain View: 60.3% in use

It is likely that electronic lockers would be more widely used than keyed lockers, and electronic lockers could be used by more than one person throughout the day instead of being assigned to an individual user, who may or may not use it daily. We support converting keyed lockers to electronic lockers at stations and coordinating bike locker management under one agency.

### 3.7 Bike share

Bike share is most appropriate for frequent, short-distance trips in a dense urban network. Bike share has seen success in San Francisco and somewhat less so in San Jose. Bike share is not practical at most stations along the Caltrain corridor due to the suburban nature of the area. For the purposes of this document, we focus on bike parking instead of bike share due to the relatively high cost of bike share.

## 4 Bikes Onboard

### 4.1 History of increasing bike capacity onboard Caltrain

There has been a long history of incremental improvements toward better bicycle access onboard Caltrain, as shown by Table 3.

Year	Bicycle Access
1992	8 bikes allowed per train
1996	24 bikes allowed per train
2002	32 bikes allowed on gallery bike cars, but only 16 bikes on new Bombardier cars; trains have either one or two bike cars
2009	40 bikes allowed on gallery bike cars and 24 bikes allowed on Bombardier bike cars; all Bombardier trains upgraded to two bike cars
2011	All gallery trains upgraded to two bike cars
Late 2016	All Bombardier trains to be upgraded to three bike cars

**Table 3:** History of bicycle access onboard Caltrain.

In 1992, eight bikes were allowed per train. The service proved to be popular, so Caltrain increased bike capacity to 24 bikes per train in 1996.

By 2002, bike capacity was maxed out, so Caltrain increased bike space to 32 bikes per train on gallery trains. Caltrain introduced new Bombardier trains into service in 2002, but the Bombardier bike cars held only 16 bikes. Some trains had one bike car and some had two, so bike capacity among trains varied from 16 to 64 bikes per train. Customers never knew which train would show up, making it uncertain whether customers with bikes would be allowed to board or not.

Bicycle bumps became a huge problem, and Caltrain addressed this in 2009 by increasing bike capacity to 40 bikes per gallery bike car and 24 bikes per Bombardier bike car, as well as upgrading all Bombardier trains to two bike cars. Gallery trains still had either one or two bike cars, so bike capacity varied from 40 to 80 bikes per train. Consistency was better than before, but service was still unpredictable with many bicyclists continuing to get bumped.

In 2011, Caltrain upgraded all gallery trains to two bike cars, resulting in bike capacity of 48 to 80 bikes per train on Bombardier trains and gallery trains, respectively. In addition, Caltrain assigned specific train types to specific runs. This helped bicyclists know what to expect, so they could better estimate their chances of being allowed to board. Unfortunately Bombardier train sets are typically assigned to baby bullet runs, the most desirable trains, systematically excluding bicyclists.

Service disruptions such as mechanical failures or accidents can result in train swaps in which a gallery train set gets replaced unannounced with a Bombardier train set. When this occurs, the lower bike capacity on Bombardier trains results in many bicycle bumps.

At the Joint Powers Board meeting on January 8, 2015, staff announced that all Bombardier trains will be upgraded to three bike cars by adding an additional car to run six-car trains.<sup>20</sup> This is a slight increase in bike capacity of just 8%, not enough to eliminate all bicycle bumps, but at least all trains will be more consistent with 72 to 80 bikes per train. The 16 new Bombardier cars will add over 15% more seats to the fleet, addressing the needs of all passengers.

## 4.2 The effect of bumping customers with bicycles

### 4.2.1 Historical bump reports

Caltrain customers voluntarily reported bumps by email to the Joint Powers Board. We have compiled these bump reports and graphed them as a function of month as shown in Figure 9. We started compiling bump reports in February 2009. Not all bumps are reported, so the graph shows the minimum number of bumps that occurred each month.

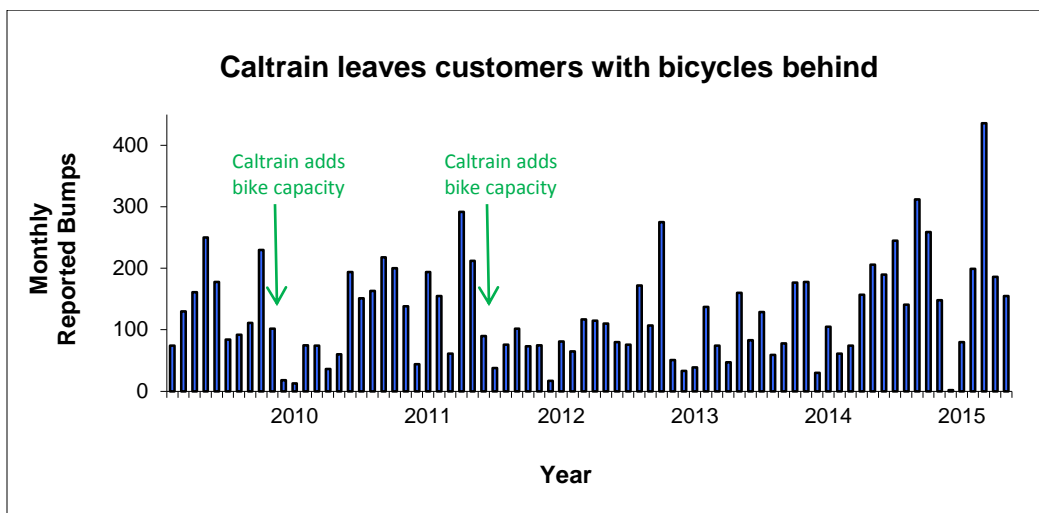

**Figure 9.** Bicycle bumps reported by customers. The bars represent bumps reported each month in the year shown. Not all bumps are reported, so actual bumps are higher than shown.

Caltrain added bike capacity in late 2009, and bumps dropped briefly, but service was still inconsistent with 40 to 80 bikes per train. Bumps were back up again later in 2010. Caltrain upgraded all trains to two bike cars in 2011, and bumps dropped off in 2012, but bumps never went down to zero. Bumps started to climb again in 2014, showing that bike space was approaching capacity.

<sup>20</sup> Peninsula Corridor Joint Powers Board of Directors Meeting Minutes of January 8, 2015, p. 9.

Both the San Francisco Bicycle Coalition and Caltrain released a streamlined way to report bumps using a Google form in mid-February and early March, respectively. The spike in March bump reports is presumably due to publicity surrounding release of the forms.

#### 4.2.2 Caltrain bump counts

Caltrain counts bicycle bumps on a subset of trains during its February annual passenger counts. Figure 10 shows bicycle bumps counted as a function of year. Bicycle bumps increased 328% from 2014 to 2015 due to bike capacity being maxed out.

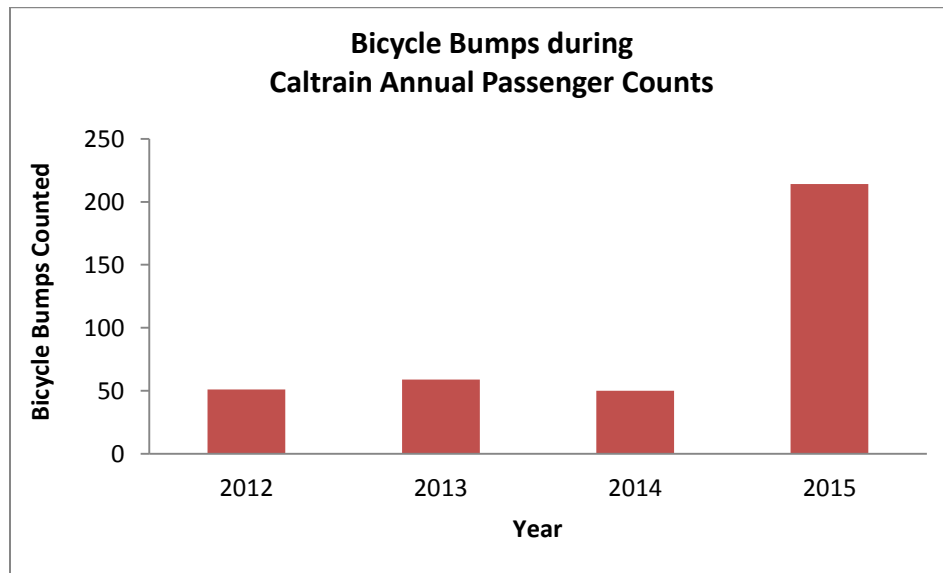

**Figure 10.** Bicycle bumps counted on a subset of trains during Caltrain annual passenger counts, which are conducted over a three to four week period in late January and February each year. The first year Caltrain started counting bumps was 2012.

#### 4.2.3 Bumps cost Caltrain ridership and revenue

Bicycle bumps cause Caltrain service to be unreliable. For those commuters who need to get to work on time, it's not merely an inconvenience; it could cost them their jobs. Many bicyclists have abandoned Caltrain and gone back to driving, because they couldn't count on Caltrain.<sup>21</sup> Bicycle bumps cost Caltrain ridership and ticket revenue, as illustrated in Figure 11.

---

<sup>21</sup>Caltrain Loses Ridership and Ticket Revenue by Denying Service to Cyclists, BIKES ONboard Project, San Francisco Bicycle Coalition, September, 2010.

### Limited Bike Capacity Dampens Bike Boardings in 2015

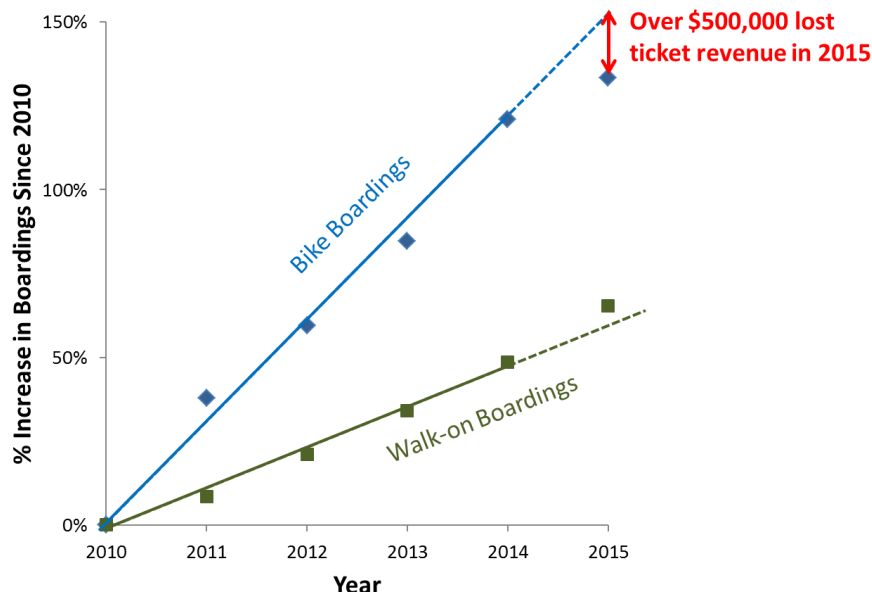

**Figure 11.** Percentage annual increase in both bike boardings and walk-on boardings relative to 2010. The increase in bike boardings fell off in 2015 due to full bike cars, costing Caltrain over half a million in lost ticket revenue in 2015. Data are from Caltrain February annual passenger counts.

As shown in Figure 11, both bike boardings and walk-on boardings were increasing approximately linearly until 2015, when bike boardings fell off. In contrast, walk-on boardings continued their same upward trajectory. Some trains have standing room only during commute periods, but limited seating capacity did not dampen walk-on boardings. This shows that customers are willing to stand on Caltrain.

However, customers are not willing to be bumped and left behind on the platform. They'll abandon Caltrain and find an alternative commute method; most will just drive alone instead. Caltrain will lose over half a million dollars in ticket revenue in 2015 due to insufficient onboard bike capacity.

While some commute period trains have standees between the two or three busiest stops, bike cars get full when there are still many empty seats on the trains. Customers with bicycles often get bumped before the train even leaves its starting station, 4<sup>th</sup> & King. Appendix B shows photos taken in 2015 that illustrate the problem.

Caltrain plans to add a third bike car to Bombardier trains to reduce bicycle bumps and bring bicycling customers back. Bike boardings should come back up after the third bike car is added in late 2015.

### 4.3 Increases in bike boardings outpace walk-on boardings

We use historical trends derived from Caltrain annual passenger counts to estimate future demand. Annual increase in bike boardings has historically outpaced increase in walk-on boardings, as shown in Figure 12. Even in 2010 during the recession when overall ridership

decreased, bike boardings declined less than walk-on boardings. This emphasizes the popularity of Caltrain’s onboard bicycle service.

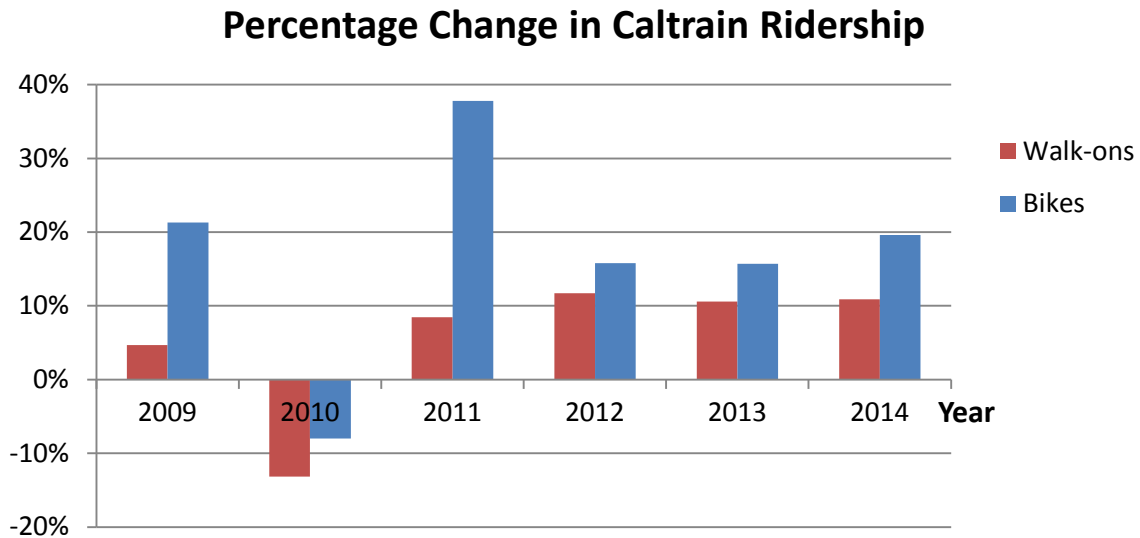

**Figure 12.** The annual increase in bike boardings outpaced walk-on boardings every year. Data are from Caltrain February annual passenger counts.

We report data from the past six years, because Caltrain added bicycle capacity in 2009 and 2011. Therefore, growth in bicycle boardings since 2008 is more representative of actual demand than prior years, when bicycle capacity was even more restricted. Over the past six years, February annual passenger counts show:

- Average annual increase in weekday walk-on boardings = 5.5%
- Average annual increase in weekday bicycle boardings = 17.1%

Bike ridership is Caltrain’s fastest growing passenger segment, increasing 147% between 2008 and 2014, while walk-on ridership increased only 35%.

It is remarkable that Caltrain bike boardings continue to increase, despite the high number of bicycle bumps. February 2014 passenger counts showed that over 11% of passengers bring a bike onboard, and a Caltrain survey showed that 13% of passengers bring a bike onboard,<sup>22</sup> whereas Caltrain has only 10% onboard bike capacity today. This indicates that bicyclists are adjusting their commutes to take shoulder period trains, just so they can bring their bikes onboard.

<sup>22</sup> Peninsula Corridor Electrification Project Final Environmental Impact Report, Peninsula Corridor Joint Powers Board, December 2014, \ p. 3.14-9.

#### 4.4 Future projected bike boardings

We used the average increases in both walk-on and bike boardings from section 4.3 to extrapolate ridership into the future. Figure 13 shows an extrapolation of bike boardings to the start of the electrification era. Over 20% of Caltrain passengers are expected to bring a bike onboard electrified trains in 2020, assuming there is sufficient onboard bike capacity.

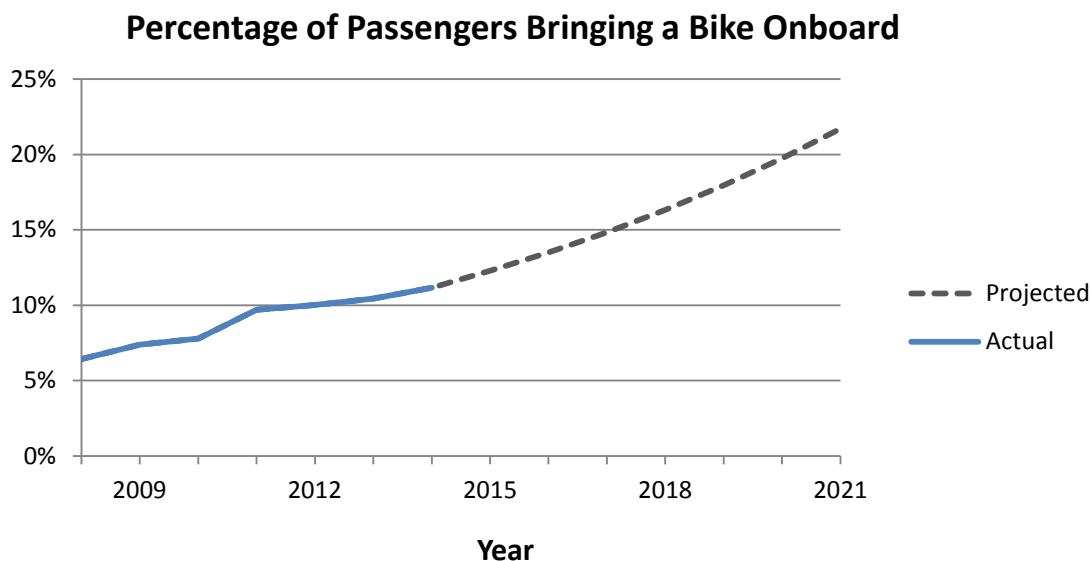

**Figure 13.** The solid blue line shows the percentage of passengers who brought a bike onboard Caltrain according to Caltrain annual passenger counts, and the dashed gray line shows projected bike boardings. Appendix A contains the raw data used to generate the graph.

The projection of 20% bike boardings in 2020 is conservative, because:

1. Currently onboard bicycle space is limited, forcing many bicyclists back into their cars due to the high frequency of bumping. The annual increase in bicycle boardings would have been even higher than 17.1%, if Caltrain had had sufficient onboard bike space.
2. February passenger counts severely understate bicycle boardings in warmer months, when bicycle boardings increase over 42% whereas walk-on boardings increase only 11% according to a comparison of Caltrain February 2004 with October 2004 passenger counts (2004 is the only year Caltrain conducted its passenger count twice).

These two points emphasize that bike capacity for 20% of passengers to bring a bike onboard electrified trains is considered a minimum.

## 5 Goals for Bike Parking and Bikes Onboard in 2020

Bike parking is an enhancement to bikes onboard, not a replacement. Bringing a bike onboard is extremely popular with Caltrain customers, and insufficient bike capacity is counterproductive. If customers cannot bring their bikes onboard, 80% never or rarely ride Caltrain, and the other 20% reduce the number of trips they take on Caltrain by 50% or more. The alternative chosen by

63% of bike/Caltrain passengers when they can't bring a bike onboard is driving alone.<sup>23</sup> Therefore, it is imperative that Caltrain provides sufficient onboard bike capacity to meet demand. Due to restricted onboard floor space, we offer a compromise between onboard bike space and bike parking, as described below.

To set a goal for bikes onboard and bike parking in 2020, we rely on the following data taken from previous sections of this document:

1. Bike boardings on Caltrain increased over 147% between 2008 and 2014.
2. Ridership trends based on Caltrain February annual passenger counts show that at least 20% of passengers would bring a bike onboard in 2020.
3. The ridership projection for bike boardings in 2020 is depressed by bicycle bumps and the fact that Caltrain ridership counts are taken in February, a time of low bike ridership.
4. Survey results suggest that over 50% of bikes-on-board passengers would hypothetically park their bikes at the station instead of bringing a bike onboard.
5. Survey results show that 27% of bikes-on-board passengers actually switched to parking at the station instead of bringing a bike onboard, when a staffed bike parking facility became available.
6. Historical bike parking statistics show that 15 to 30% of people who biked to the station parked at a staffed bike parking facility.

Assuming the ridership projection for bike boardings in 2020 is depressed by 1% due to item 3 above, then projected bike boardings would be 21% in 2020. Based on items 5 and 6 above, bike boardings could be reduced to 16% in 2020, if adequate staffed bike parking facilities are available. Based on item 1, Caltrain needs to find ways to entice more people to park their bikes at the station, and item 4 suggests that Caltrain should try to achieve an equal number of passengers biking to the station as bringing a bike onboard, that is, 16% in 2020.

Past ridership shows it will be easy to achieve the goal of 16% of passengers bringing a bike onboard in 2020, and more challenging to achieve the goal of 16% of passengers parking a bike at the station. Nonetheless, the economic, social, and environmental benefits of bicycling are so compelling that Caltrain should not pass over the opportunity to shift station access mode share away from motorized transportation and toward bicycling. We encourage Caltrain to start now to improve bicycle parking amenities to achieve the 16% goal by 2020. The most effective bike parking option is a staffed valet bike parking facility. A strong publicity campaign will be needed to make potential customers aware of bike parking options at stations.

We have calculated the theoretical maximum percentage of passengers who would bike to Caltrain as nearly 40%,<sup>24</sup> so setting a goal of 32% (16% onboard and 16% bike parking) is not unreasonable. Over 40% of passengers bike to train stations in bicycle-friendly countries like Holland.<sup>25</sup> We encourage Caltrain to strive to achieve a goal of increasing bicycle mode share to 32%.

---

<sup>23</sup> 2007 Caltrain Online Bicycle Survey, *Op. cit.*

<sup>24</sup> Plan for Bicycle Carriage on Caltrain, Peninsula Corridor Joint Powers Board, October 2008, p. 16.

<sup>25</sup> Replogle, Michael and Harriet Parcels, Linking Bicycle/pedestrian Facilities with Transit, Federal Highway Administration, 1992, p. 56.



To reiterate the goal for 2020:

- Bike capacity sufficient for 16% of passengers to bring a bike onboard electrified trains
- Sixteen percent of passengers park bikes at the station.

Caltrain has recently been awarded a grant to develop a bicycle parking management plan.<sup>26</sup> We recommend that the plan be written to achieve the goal of 16% of passengers parking bikes at stations by 2020.

## 6 Electric Multiple Unit Design

### 6.1 Space allocation for seats/standees/bikes

Caltrain staff is recommending no increase in bike capacity compared with bike capacity after the third bike car is added to Bombardier trains, where bike capacity is defined as the ratio of seats to bike spaces. Staff is concerned that a bike space takes the place of one seat. To reduce the number of standees on busy trains, staff is recommending no increase in bike capacity. This recommendation is sadly out of touch with the future, as bicycling is becoming ever more popular.

Staff provided an estimate of maximum hourly load during commute periods running six six-car trains per hour, as shown in Table 4. Two ratios are shown for the example EMU, 9:1 and 6:1. These ratios correspond to 11% and 16% bike capacity, respectively. The 6:1 ratio would underserve Caltrain customers wanting to bring a bike onboard electrified trains, as it refers to physical space on the train and does not translate directly to percentage of passengers bringing a bike onboard when there are standees.

seat:bike ratio	seated passengers carried @ max load	bikes carried @ max load	Standees carried @ max load	total riders carried @ max load (max-pax)	% of max-pax who could bring bikes	% of max-pax who could sit	% of max-pax who would stand
10 :1 (today)	5330	551	1722	7052	7.80%	75.58%	24.40%
9:1 (add Bomb cars)	5743	630	1919	7662	8.20%	74.95%	25.00%
9:1 (example EMU)	6459	682	3758	10217	6.70%	63.32%	36.80%
6:1 (example EMU)	6250	877	3758	10008	8.80%	62.50%	37.60%

**Table 4:** Estimated maximum load of EMUs during peak commute period.

Table 4 shows that more bike space would result in more standees at peak load. However, the increase in passengers having to stand is only 0.8%, not a significant change when more than 36% of passengers are already standing. Most standees stand for less than 10 minutes between the two busiest stops with no delay in their arrival time. Being bumped and left behind on the platform can delay a customer with a bicycle up to one hour.

<sup>26</sup> Peninsula Corridor Joint Powers Board of Directors Meeting Minutes of June 4, 2015, p. 12.

According to Table 4, the increase in bikes carried at max load is approximately 200, which equates to 200 customers per hour being able to ride the train instead of being left behind on the platform. This would have a huge impact on travel time, reliability, and convenience for these customers, and would encourage them to continue to rely on Caltrain instead of reverting back to driving.

Caltrain has hit on a winning service model of bikes onboard trains, and the agency needs to nurture and grow the service. A bike onboard rivals the automobile in convenience and flexibility, making the service extremely popular among Caltrain passengers. Caltrain needs to plan for the future, and design EMUs appropriate for all passengers. To that end, EMUs should be designed with conversion-compatible space, so that adjustments to seat:bike ratio can be made in the future, if need be.

## 6.2 Caltrain needs to run longer electrified trains

While peak load is important, it is also important to show that Caltrain can meet demand for total ridership. Table 5 shows actual ridership from Caltrain’s 2015 annual passenger counts and projections for total ridership in 2020.<sup>27</sup>

Year	Actual Ridership Count	Total Ridership from EIR	Total Ridership from Extrapolation of Past Ridership
2015	58,245	--	--
2020 (without electrification)	--	57,047	76,551
2020 (with electrification)	--	69,151	--

**Table 5:** Actual and projected total ridership on Caltrain. Projected total ridership is taken from the final Environmental Impact Report (EIR) for electrification, which estimates ridership with and without electrification. The extrapolation from past ridership trends can be found in Appendix A of this document.

Caltrain’s EIR uses a model to predict future ridership, but that model is obviously inaccurate. The model prediction for total ridership in 2020, if Caltrain did not electrify its line, has already been surpassed in 2015 by actual ridership. A straightforward extrapolation of past ridership trends suggests that the model under predicts ridership by over 30%. One obvious flaw in the model is that it excludes bicycling as a station access mode, even though 14% of Caltrain passengers access Caltrain by bike.<sup>28</sup>

Caltrain needs to run longer trains for the following reasons:

- Caltrain severely underestimates future ridership as shown in Table 5.
- Table 4 shows that Caltrain’s service standard policy of a load factor of 1.2, or 17% of people standing, will not be met with six-car trains.
- Six-car trains will not be able to meet projected demand for bike boardings.

<sup>27</sup> Peninsula Corridor Electrification Project Final Environmental Impact Report, Peninsula Corridor Joint Powers Board, December 2014, Appendix I, p. 17.

<sup>28</sup> Peninsula Corridor Electrification Project Final Environmental Impact Report, *Op. cit.*, p. 3.14-9.

Caltrain must seek funding to purchase additional rail cars and extend platform length for electrified trains. EMUs for the longer trains must meet passenger demand; therefore they should be designed to accommodate at least 16% of passengers bringing a bike onboard, or 5:1 ratio of seats:bikes at 1.2 load factor. If EMUs are designed appropriately, then Caltrain can avoid expensive retrofits later.

We recommend a new service standard policy that no passenger with a paid ticket gets left behind on the platform. The only way to achieve this new policy is with longer trains than the currently planned six-car trains.

### **6.3 Level boarding**

Level boarding is good for all passengers, particularly those with strollers, wheelchairs, luggage, and bicycles. While the situation is complex due to the desire to be compatible with future high-speed rail platforms, we encourage Caltrain to find ways to ensure that EMUs will have level boarding with no requirement for passengers with bicycles to use stairs inside the trains.

### **6.4 Bike space in all cars improves operations**

We recommend equal bike space in all EMUs. Requiring one passenger segment to enter a limited number of doors, as for designated bike cars, can create bottlenecks at those doors. Dwell time can be reduced when passengers are able to self-regulate and distribute boarding more evenly at all doors.

Identical rail cars simplifies operations, because operations personnel do not have to carefully configure trains with specific cars. This is especially important when train length is varied or cars are removed for maintenance.

## **7 Summary of Recommendations**

### **Bicycle Mode Share**

We recommend that Caltrain set a goal of 32% of passengers accessing stations by bicycle in 2020, achieved as follows:

- Bike capacity sufficient for 16% of passengers to bring a bike onboard electrified trains
- Sixteen percent of passengers park bikes at the station

### **Train Length**

To accommodate future ridership and meet the service standard policy of 1.2 load factor, Caltrain needs to run longer trains than the currently planned six-car trains. We encourage Caltrain to identify funding to purchase additional EMUs and extend platform length.

### **Service Standard Policy**

We ask that Caltrain adopt a new service standard policy that no customer with a paid ticket gets left behind on the platform.

## **EMU Design**

For EMU design, we recommend:

- 5:1 ratio of seats:bikes to allow 16% of passengers to bring a bike onboard at 1.2 load factor
- Equal bike capacity in all cars
- Level boarding with no requirement to use stairs inside the train to reach the bicycle storage area
- Conversion-compatible space to easily increase bike capacity in the future, if needed

## **8 Appendices**

Appendix A: Data for extrapolation of Caltrain ridership into the future

Appendix B: Photos of bike and non-bike cars taken in 2015

## Appendix A: Data for extrapolation of Caltrain ridership into the future

### Caltrain Projected Ridership Based on February Annual Passenger Counts

*Projections in blue italics*

Year	average weekday ridership (AWR)	% increase in AWR	walk-on boardings	% increase in walk-ons	bike boardings	% increase in bike boardings	% bicycle passengers
2008	36993		34611		2382		6.44%
2009	39122	5.76%	36232	4.68%	2890	21.33%	7.39%
2010	34120	-12.79%	31461	-13.17%	2659	-7.99%	7.79%
2011	37779	10.72%	34115	8.44%	3664	37.80%	9.70%
2012	42354	12.11%	38111	11.71%	4243	15.80%	10.02%
2013	47060	11.11%	42150	10.60%	4910	15.72%	10.43%
2014	52611	11.80%	46737	10.88%	5874	19.63%	11.16%
<i>2015</i>	<i>56004</i>	<i>6.45%</i>	<i>49129</i>	<i>5.52%</i>	<i>6876</i>	<i>17.05%</i>	<i>12.28%</i>
<i>2016</i>	<i>59617</i>	<i>6.45%</i>	<i>51569</i>	<i>5.52%</i>	<i>8048</i>	<i>17.05%</i>	<i>13.50%</i>
<i>2017</i>	<i>63462</i>	<i>6.45%</i>	<i>54042</i>	<i>5.52%</i>	<i>9420</i>	<i>17.05%</i>	<i>14.84%</i>
<i>2018</i>	<i>67555</i>	<i>6.45%</i>	<i>56529</i>	<i>5.52%</i>	<i>11026</i>	<i>17.05%</i>	<i>16.32%</i>
<i>2019</i>	<i>71913</i>	<i>6.45%</i>	<i>59007</i>	<i>5.52%</i>	<i>12906</i>	<i>17.05%</i>	<i>17.95%</i>
<i>2020</i>	<i>76551</i>	<i>6.45%</i>	<i>61444</i>	<i>5.52%</i>	<i>15106</i>	<i>17.05%</i>	<i>19.73%</i>
<i>2021</i>	<i>81488</i>	<i>6.45%</i>	<i>63806</i>	<i>5.52%</i>	<i>17682</i>	<i>17.05%</i>	<i>21.70%</i>

Average annual increase in ridership from 2008 to 2014

AWR	walk-ons	bikes
6.45%	5.52%	17.05%

% increase in bike boardings 2008 – 2014: 146.6%

% increase in walk-on boardings 2008 – 2014: 35.0%

% increase in AWR 2008 – 2014: 42.2%

## Appendix B: Photos of bike and non-bike cars taken in 2015

The photos show that both bike cars get filled to capacity while the rest of the train has many empty seats.

### SB Train 230, 22nd Street



Bike car #1



Bike car #2



Adjacent car

### SB Train 324, 22nd Street



Bike car #1



Bike car #2



Adjacent car



**NB Train 279, Redwood City**



Bike car #1



Bike car #2



Adjacent car

**SB Train 220, 22nd Street**



Bike car #1



Bike car #2



Adjacent car

## McKenna, Nancy

---

**From:** Sami Laine <sami.laine@gmail.com>  
**Sent:** Wednesday, July 01, 2015 12:37 AM  
**To:** Board (@caltrain.com); cacsecretary (@caltrain.com); Caltrain, Bac (@caltrain.com)  
**Cc:** janice@sfbike.org; bikesonboard@sfbike.org  
**Subject:** I Support More Bike Space On Board and More Bike Parking for Caltrain

Thanks for all the hard work on ensuring the critical multimodal access to Caltrain.

I live in Cupertino and accepted a great new job in SF this March. Having secure bike parking at my local Caltrain station 6 miles away in Sunnyvale and ability to rely on bike access on Caltrain was a critical factor in being able to make this career decision.

Bike ridership is growing at tremendous pace and continued bike access at stations and trains is going to more critical in the coming years. You are making a decision affecting a growing percentage of Bay Area residents for their lifetime. Please ensure adequate access to this critical infrastructure to keep our region thriving and healthy (in more ways than one)!

Thank you for your consideration,

Mr. Sami Laine  
6189 Shadygrove Dr  
Cupertino, CA 95014  
408-799-6185

Sent from my iPhone



## McKenna, Nancy

---

**From:** Gunter Steffen <gsteffen1@sbcglobal.net>  
**Sent:** Tuesday, June 30, 2015 11:35 PM  
**To:** Board (@caltrain.com)  
**Cc:** bikesonboard@sfbike.org; Nabong, Sarah; Murphy, Seamus; cacsecretary (@caltrain.com); Caltrain, Bac (@caltrain.com)  
**Subject:** Bikes on Board

This should be a no-brainer. With the anticipated increase in growth of bike ridership even over the next five years it should be patently obvious that we need more bike cars in the future. I hear no one talking about expansion of transportation infrastructure that will carry people to and from the train stations that serve the Peninsula and I see no moves afoot to increase parking at any of those stations so people have to ride their bikes in order to use the trains. If people get "bumped" due to lack of capacity they will most likely drive to work and add to the congestion and pollution that is effecting our health, our climate, and our economy and not for the better. If you are planning for the future, then please consider the need for additional (adequate) bike capacity on the trains and act accordingly. We'll all benefit in the long run.

Gunter Steffen

## McKenna, Nancy

---

**From:** Lauren Fondahl <lfondahl@aol.com>  
**Sent:** Tuesday, June 30, 2015 7:43 PM  
**To:** Board (@caltrain.com)  
**Cc:** bikesonboard@sfbike.org; janice@sfbike.org; Nabong, Sarah; Murphy, Seamus; cacsecretary (@caltrain.com); Caltrain, Bac (@caltrain.com)  
**Subject:** More bicycle ease-of access on board and More Bike Parking needed for Caltrain

I understand that Caltrain is looking at whether to add more space for bicyclists as well as ease of access for everyone and bike parking, and strongly support this. I have recently been commuting more between San Francisco and Palo Alto's California Street Station, and prefer this to driving. However, as a 4'11" tall woman in her 60's, I always need someone to assist me in getting my bicycle up the narrow, steep stairs of the train and into the cabin. Fortunately there always seems to be a taller person around very willing to assist, but I imagine there are many for whom this difficulty in boarding would be a deterrent. It would also be useful to have some bicycle parking quarters where one could park a bicycle overnight and have it relatively secure, if they are in San Francisco for part of the week and on the Peninsula for another part of the week. The bicycle racks at the California Street Station seem to be fairly safe during the day time, but I would be afraid to park a bicycle there overnight.

Thank you, and glad to see so many more people using bicycle + Caltrain as their commute mode. Hope this trend continues!

Lauren Fondahl  
562 Bright St/  
San Francisco

## McKenna, Nancy

---

**From:** Lawrence Li <lawrence@bureausf.com>  
**Sent:** Tuesday, June 30, 2015 7:38 PM  
**To:** bboard@caltrain.com; cacsecretary (@caltrain.com); Caltrain, Bac (@caltrain.com)  
**Cc:** janice@sfbike.org; bikesonboard  
**Subject:** Please pass good Caltrain design

Dear Caltrain Board,

I live in San Francisco and regularly commute on Caltrain to San Jose, with stops along the way. I thank staff for recommending \$3 million as an investment for secure bike parking. Please approve this necessary recommendation.

I witness a shortage of bike capacity on board the trains. Please pass a design that provides bike facilities for at least 16% of Caltrain passengers.

In addition, because Caltrain is a core part of transportation around the Bay, it should be official goal that 20% of passengers will access the system by bicycle by 2020.

Regards,  
Lawrence Li  
498 Waller St Apt 9, San Francisco CA 94117

## McKenna, Nancy

---

**From:** Bob Donjacour <donjacour@yahoo.com>  
**Sent:** Tuesday, June 30, 2015 7:28 PM  
**To:** Board (@caltrain.com); cacsecretary (@caltrain.com); Caltrain, Bac (@caltrain.com)  
**Cc:** janice@sfbike.org; bikesonboard@sfbike.org  
**Subject:** I Support More Bike Space On Board and More Bike Parking for Caltrain

To the Caltrain Board,

I am a bike commuter and have been since 1999. I have commuted on Caltrain between Milbrae and Palo Alto.

Bike and Caltrain makes so much sense in terms of a relaxing healthful commute and a commute that does not spew carbon into our atmosphere.

Most important to a bike commuter is being able to board a train. If you might get turned away because a bike car is full you won't risk it.

Please make sure your facilities and policies on the new electrified commuter trains allow confidence that a bike rider will get to their destination.

Secure bike parking also makes riding Caltrain workable. Make sure stations have this option.

I am a member of SFBC and I want to recommend some targets they have come up with.

- bike capacity for at least 16% of passengers.
- by 2020, at least 20% of passengers will ride a bike to the station.
- keep on recommending the \$3 million investment in secure bike parking.

Thanks,

Bob Donjacour  
415 334 5655

**McKenna, Nancy**

---

**From:** Veeren Mandalia <veeren.mandalia@gmail.com>  
**Sent:** Tuesday, June 30, 2015 7:22 PM  
**To:** Board (@caltrain.com); cacsecretary (@caltrain.com); Caltrain, Bac (@caltrain.com)  
**Cc:** bikesonboard@sfbike.org; janice@sfbike.org  
**Subject:** I Support More Bike Space On Board and More Bike Parking for Caltrain

This will be great, making the bay area more accessible by bike will increase ridership and support existing riders. Hopefully this will steer more people from driving to riding the train.

## McKenna, Nancy

---

**From:** Jaime <jaime9999@gmail.com> on behalf of Jaime Guerrero <jaime@low-impedance.com>  
**Sent:** Tuesday, June 30, 2015 7:14 PM  
**To:** Board (@caltrain.com); cacsecretary (@caltrain.com); Caltrain, Bac (@caltrain.com)  
**Cc:** janice@sfbike.org; bikesonboard@sfbike.org  
**Subject:** I Support More Bike Space On Board and More Bike Parking for Caltrain

Hello

Please be sure:

- the design of new trains provide bike capacity equal to or greater than current. At least  $1/6 = 16\%$  of passengers
- make it a goal that 20% of passengers use cycling to access CalTrain
- approve the \$3m investment in bike parking

Thanks

Jaime Guerrero  
Caltrain Rider: SF to Menlo Park

3118 18th St, #2, San Francisco

## McKenna, Nancy

---

**From:** Michael Heylin <mtheylin@gmail.com>  
**Sent:** Tuesday, June 30, 2015 7:08 PM  
**To:** Board (@caltrain.com); cacsecretary (@caltrain.com); Caltrain, Bac (@caltrain.com)  
**Cc:** janice@sfbike.org; bikesonboard@sfbike.org  
**Subject:** I Support More Bike Space On Board and More Bike Parking for Caltrain

As a San Francisco resident, I strongly support having ample bicycle parking and space on the Peninsula corridor trains at as many stops as possible, so that riders can use their own transportation when then get to the City and to/from their homes, as well as having pollution-free transit wherever their destination may be along the route.

Please consider a reasonable budget of funds AND storage space aboard the rails in your July 2 meeting.

Thank you.

*Michael Heylin*  
m: (415) 531-4656  
*Proud member, San Francisco Bicycle Coalition*

## McKenna, Nancy

---

**From:** Alastair Warren <alastair@alastairwarren.com>  
**Sent:** Tuesday, June 30, 2015 6:53 PM  
**To:** Board (@caltrain.com); cacsecretary (@caltrain.com); Caltrain, Bac (@caltrain.com)  
**Cc:** janice@sfbike.org; bikesonboard@sfbike.org  
**Subject:** I Support More Bike Space On Board and More Bike Parking for Caltrain

Dear Caltrain Board,

As a regular Caltrain commuter with and without my bike, I truly appreciate Caltrain's commitment to people who cycle and ride. I make use of the bike parking at 4th & King frequently, and sometimes take my bike onboard, although overcapacity can be a challenge.

I'm absolutely in favor of providing as much capacity as possible onboard, and making an official goal of having 20% of riders access Caltrain by bike. I'm also thrilled a \$3 million investment has been recommended—it's great to see Caltrain taking such a progressive stance.

Thank you for helping out those who choose to cycle.

Alastair Warren  
Hayes Valley



## McKenna, Nancy

---

**From:** Paige Miller <apaige.miller@gmail.com>  
**Sent:** Tuesday, June 30, 2015 6:45 PM  
**To:** Board (@caltrain.com); cacsecretary (@caltrain.com); Caltrain, Bac (@caltrain.com)  
**Cc:** Janice Li; bikesonboard@sfbike.org  
**Subject:** I Support More Bike Space On Board and More Bike Parking for Caltrain

Dear Joint Powers Board,

I am unable to join you for your meeting this week, so I am writing you with my comments as a daily Caltrain rider and bike commuter.

In the short eight months that I have been riding Caltrain, I have noticed the bike cars getting more and more crowded. It is clear that bike capacity is in demand, and that demand is going up.

To ensure that the new Caltrain car design truly serves all riders, please consider the following suggestions:

1. Please pass a design that provides bike capacity for at least 16% of Caltrain passengers.
2. Please make it an official goal that at least 20% of Caltrain passengers will access the system by bike by 2020
3. I would like to thank Caltrain staff for recommending a significant \$3 million investment in secure bike parking - please approve this recommendation.

Thank you,  
Paige Miller  
Inner Richmond, San Francisco

## McKenna, Nancy

---

**From:** Mateo Burtch <commie@sonic.net>  
**Sent:** Tuesday, June 30, 2015 6:17 PM  
**To:** Board (@caltrain.com); cacsecretary (@caltrain.com); Caltrain, Bac (@caltrain.com)  
**Cc:** janice@sfbike.org; bikesonboard@sfbike.org  
**Subject:** Please Support Bikes on Caltrain

Hi there--

As a long-time Caltrain bike rider (I go back to the very earliest days of the pilot program, when cyclists needed a permit to bring a bike on board Caltrain), I want to urge the board to please go with a car design that maximizes space for bikes--at least 16% of space, as well as to adopt the 20% bike ridership goal for 2020.

Also, thanks to those who recommended the \$3 million investment in bike infrastructure.

As someone who doesn't own a car, Caltrain is an essential part of my transportation.

Thank you!

Mateo Burtch  
San Francisco

## McKenna, Nancy

---

**From:** Ciara Gallagher <spacerangerlady@gmail.com>  
**Sent:** Tuesday, June 30, 2015 5:55 PM  
**To:** Board (@caltrain.com)  
**Cc:** bikesonboard@sfbike.org; Nabong, Sarah; Murphy, Seamus; cacsecretary (@caltrain.com); Caltrain, Bac (@caltrain.com)  
**Subject:** Increase Bike Capacity on Electrified Trains

Dear sir, dear madam,

I am writing to add my name to the list of people requesting increased bike capacity on electrified trains. I commute from Redwood City to San Francisco every weekday and buy a monthly pass each month. I love Caltrain! The conductors are friendly, the trains are clean and for the most part run on time. I take my bike on the train and in the bike car I have met some fantastic people. I am six months pregnant and being able to combine bike and train allows me to get to work in a reasonable time. I cycle 1.5 miles to Sequoia Station from home - this takes me about 10 minutes whereas walking would take me much longer! I cycle 1 mile from Caltrain 4th and King to work - while this distance is walkable I appreciate getting to the train faster if I have my bike - especially when I don't remember to check the clock! I also use my bike to run errands in the city before I head home again. My daily commute, including being early for the train to get a good spot in the queue, is one hour each way. This would increase if I was not able to bring my bike on the train.

I think the demand for bike capacity may even be underestimated. Frequently additional bikes are allowed on the train, which while great for commuters, is underestimating the demand for bike space. I take the NB 319 that departs RWC at 7.30am. Recently, more and more bikes are getting bumped from this train. We are usually around twelve bikers for the front bike car on any given weekday, many times the train arrives with only two or three spots open for bikes. Once I was bumped and was almost bumped again from the following train (7.45am) - only the three bikers who had been bumped from the 7.30am got a spot, everyone else who turned up for the 7.45am was bumped. Then on my commute home that day I was bumped again despite arriving at 5.25pm for the 5.33pm departure. It is clear that the demand for bike space is huge, especially at our station. I would be prepared to leave my bike at Sequoia Station if there were a safe place to do so - currently all 50 of the bike lockers there are full.

Many people have compiled facts and figures about bikes on Caltrain - summarized in the email below from bikes on board. I am writing to ask that the capacity for bikes on the electrified trains be increased so that in the future this great option to combine cycling and taking the train is available for all of us. It has made a huge difference for me during my pregnancy and I am grateful to Caltrain and all its staff for such a great service.

Many thanks and best wishes,

Ciara Gallagher  
Redwood City.

---

**From:** [Bikes on Board](#)  
**Sent:** 5/26/2015 6:45 PM  
**Subject:** ACTION ALERT! Tell Caltrain to add bike capacity on electrified trains

Hello Bicycle Commuters and Supporters,

Caltrain staff is recommending NO INCREASE in bike capacity on electrified trains in 2020, and the Board will vote on staff's recommendation on July 2. Staff has always said relief is coming with electrification, but now they say they won't increase bike capacity compared with today.

With your help, we've been able to change staff's mind in the past, so let's do it again. *This is our last chance to speak up before the Board decision on the new rail cars!* Please help with the actions below.

**ACTION #1:** Email Caltrain by June 30 to increase bike capacity on electrified trains

**ACTION #2:** Attend the Caltrain Board meeting on July 2

**ACTION #1: EMAIL CALTRAIN BY JUNE 30 TO INCREASE BIKE CAPACITY ON ELECTRIFIED TRAINS**

Bicycle bumps are at an all-time record high, and we can only imagine how bad it will be by 2020 when Caltrain electrifies. Tell Caltrain they need to plan for more passengers bringing bikes onboard in 2020, not the same as today. Every email counts!

Please send your email to: [board@caltrain.com](mailto:board@caltrain.com) and cc: [bikesonboard@sfbike.org](mailto:bikesonboard@sfbike.org), [nabongs@samtrans.com](mailto:nabongs@samtrans.com), [murphys@samtrans.com](mailto:murphys@samtrans.com), [cacsecretary@caltrain.com](mailto:cacsecretary@caltrain.com), [bac@caltrain.com](mailto:bac@caltrain.com)

Suggested talking points:

1. Tell Caltrain why you bring your bike onboard, and how much you appreciate the service.
2. Express disappointment that staff is recommending the same bike capacity for electrified service in 2020 as today.
3. State that Caltrain needs to increase bike capacity on electrified trains to accommodate the growing demand. Add some facts (see below), if you wish.
4. Express understanding that Caltrain needs to balance seats, bike space, and standing space on new rail cars, but remind Caltrain that bringing a bike onboard has economic, environmental, and social benefits (e.g., saves parking spaces in crowded parking lots, frees up seats on heavily subsidized feeder buses and shuttles, reduces traffic congestion, reduces pollution, improves public health).
5. Ask Caltrain to increase bike capacity on electrified trains to at least 16%, preferably 20% to meet latent demand and allow for future growth.
6. Include your city of residence with your signature.

Facts derived from Caltrain's February annual passenger counts:

+ Bikes-on-board passengers are Caltrain's fastest growing customer segment: bike boardings increased 147% from 2008 to 2014, while walk-on boardings increased only 35%.

+ Bicycle bumps increased 328% from 2014 to 2015.

+ In 2008, 6% of Caltrain passengers brought their bikes onboard. In 2014, 11% of Caltrain passengers brought their bikes onboard. At that growth rate (suppressed by bicycle bumps), 16% of passengers will bring their bikes onboard electrified trains.

+ Bicycle boardings increased 42% in October compared with February, whereas walk-on boardings increased only 11% (data from Caltrain's 2004 passenger counts, the only year Caltrain counted twice).

+ The average annual increase in bicycle boardings between 2008 and 2014 was over 17%, but the increase dropped to 5.7% in 2015 due to bicycle bumps. In contrast, the average annual increase for walk-on boardings was 5.5% between 2008 and 2014, but the increase jumped to 11% in 2015, even though some commute-period trains have standing room only.

For additional background information and justification for 20% bike capacity, please see the presentation here: [https://www.sfbike.org/wp-content/uploads/2015/01/Presentation\\_Bikes\\_on\\_Electrified\\_Trains\\_SFBC\\_v1.pdf](https://www.sfbike.org/wp-content/uploads/2015/01/Presentation_Bikes_on_Electrified_Trains_SFBC_v1.pdf)

## **ACTION #2: ATTEND CALTRAIN BOARD MEETING ON JULY 2**

Caltrain staff will ask the Board to approve NO INCREASE in bike capacity on electrified trains at the Board meeting on July 2. If staff has their way, the future of bikes onboard looks really grim. *Remember, this will be our last chance to speak up before the Board makes its decision!* We need you at the meeting to ask the Board for more bike capacity!

Meeting time: 10am

Date: Thursday, July 2

Place: 1250 San Carlos Ave, San Carlos (two blocks from the San Carlos Caltrain station)

This is an important time for the future of bikes onboard Caltrain. Please help! Thank you!

Please forward this email to other bicyclists and anyone who cares about bicycle commuting.

More bikes, no bumps,

Shirley Johnson

BIKES ONboard project

San Francisco Bicycle Coalition  
[sfbike.org/bob](http://sfbike.org/bob)

## McKenna, Nancy

---

**From:** Sherry Wang <sherrythewang@gmail.com>  
**Sent:** Tuesday, June 30, 2015 5:45 PM  
**To:** Board (@caltrain.com); cacsecretary (@caltrain.com); Caltrain, Bac (@caltrain.com)  
**Cc:** janice@sfbike.org; bikesonboard@sfbike.org  
**Subject:** I Support More Bike Space On Board and More Bike Parking for Caltrain

First, a big thank you to the Caltrain staff for recommending a significant \$3 million investment in secure bike parking. Having been a Caltrain rider for 4 years, and preaching its virtues to co-workers to try and recruit more riders, I often ran into folks who didn't take Caltrain because they had no where to put their bikes before or after their rides. I would encourage the Board to approve this recommendation.

I'd also like to urge the Caltrain Board to pass a design that provides bike capacity for at least 16 percent of Caltrain passengers. There's nothing more frustrating than not being able to get on a train because the bike cars are at capacity. One time, I saw train after train pass for 2 hours before I was able to get onto an overly stuffed bike car to get home. If ever there is a deterrent for getting higher ridership, that would be a major one.

Thank you,  
Sherry Wang

## McKenna, Nancy

---

**From:** Mike Vladimer <michael.vladimer@gmail.com>  
**Sent:** Tuesday, June 30, 2015 5:36 PM  
**To:** Board (@caltrain.com); cacsecretary (@caltrain.com); Caltrain, Bac (@caltrain.com)  
**Cc:** janice@sfbike.org  
**Subject:** Supporting Bikes on Caltrain

Caltrain board-

I'm writing to urge you to follow SF Bike Coalition's suggestions for designing a system to truly serve all riders. Personally, I've logged many instances where the bike car is full -- we need more space for people with bicycles:

<https://twitter.com/mikevladimer/status/615676591159447552>

<https://twitter.com/mikevladimer/status/613749449152540672>

<https://twitter.com/mikevladimer/status/613373685882204161>

Specifically I:

- Urge the Caltrain Board to pass a design that provides bike capacity for at least 16 percent of Caltrain passengers;
- Support the transit agency making it an official goal that at least 20 percent of Caltrain passengers will access the system by bike by 2020; and
- Thank Caltrain staff for recommending a significant \$3 million investment in secure bike parking and encourage the Board to approve this recommendation.

best

Mike

Regular rider: 4th & King to Sunnyvale



## McKenna, Nancy

---

**From:** Henry Mayer <hmayer00@gmail.com>  
**Sent:** Tuesday, June 30, 2015 5:29 PM  
**To:** Board (@caltrain.com)  
**Cc:** bikesonboard@sfbike.org; Nabong, Sarah; Murphy, Seamus; cacsecretary (@caltrain.com); Caltrain, Bac (@caltrain.com)  
**Subject:** Bike capacity on electrified trains

Hello Caltrain!

First off, I really want to thank you guys for all that you do. I used to drive from SF down to Menlo Park every day for work, and it was eating my soul. Since i started biking to/from the caltrain every day, my life has been enormously improved.

However, the bike/caltrain method is not without its own issues. Bike crowding is unfortunate, but of course bike-bumps are far worse. I've had many a night when I was supposed to get home for dinner, or to SF for a show, or some other obligation, and have been unable to get there in time due to a bike-bump. I've had other days when I've left work very early because I just couldn't risk a bump.

So I was saddened to hear that caltrain isn't planning on increasing the bike capacity in the coming years. I see people get bumped all the time, and I've heard multiple people tell me that's why they don't use the train. Despite that, it seems like every few months another friend or coworker has taken the plunge and started bike/training, and I expect that increase to continue unless things get to crowded.

So please, please increase the bike capacity. I love the service, but I badly want it to keep working, and keep growing.

Thanks so much for your time.

Henry Mayer, San Francisco

## McKenna, Nancy

---

**From:** Jennifer Mao <jennmao176@yahoo.com>  
**Sent:** Tuesday, June 30, 2015 5:13 PM  
**To:** cacsecretary (@caltrain.com); Caltrain, Bac (@caltrain.com); Board (@caltrain.com)  
**Cc:** janice@sfbike.org; bikesonboard@sfbike.org  
**Subject:** Bike Space & Bike Parking for CalTrain

Attn: Caltrain management

As a San Francisco resident for 5+ years, and avid cyclist, please consider the following requests:

- Urge the Caltrain Board to pass a design that provides bike capacity for at least 16 percent of Caltrain passengers;
- Support the transit agency making it an official goal that at least 20 percent of Caltrain passengers will access the system by bike by 2020; and
- Thank Caltrain staff for recommending a significant \$3 million investment in secure bike parking and encourage the Board to approve this recommendation.

Biking helps alleviate traffic and smog!

Thanks,  
Jennifer Mao  
SF resident

## McKenna, Nancy

---

**From:** Rarden, Marc <mrarden@Advent.COM>  
**Sent:** Tuesday, June 30, 2015 5:11 PM  
**To:** Board (@caltrain.com); cacsecretary (@caltrain.com); Caltrain, Bac (@caltrain.com)  
**Cc:** janice@sfbike.org; bikesonboard@sfbike.org  
**Subject:** I Support More Bike Space On Board and More Bike Parking for Caltrain

Hello folks,

I've been commuting by bike in the Bay Area for 20 years now. I've lived on the Peninsula and in San Francisco during this time, and I've used Caltrain extensively during those decades.

I'm encouraged to see that Caltrain has recommended a \$3 million investment for secured bike parking. That's strongly needed and massively appreciated. I hope the Board approves the recommendation as it's an invaluable investment.

I'd like to see the Board commit to continued improvement in bike capacity as well. Being a cyclist and Caltrain rider years ago, I had to sit on the floor next to my bike more often than I liked due to lack of effective space. I hope that you are planning enough capacity to handle future Caltrain passengers as more and more people embrace cycling. It's wonderful to see how many people have taken up this mode of transportation and it's even better when the infrastructure moves in step with it.

As such, I support increased support for Caltrain passengers accessing the system by bike. The numbers are trending up and seem certain to continue to do so. Having a system in place to allow people to seamlessly join the flow is a great thing. Let's plan for it and embrace it.

Thank you for your support of the biking community, come on a ride with us if you are curious about it, and please continue to fund and commit to the infrastructure that is needed and appreciated.

Regards,  
Marc Rarden

## McKenna, Nancy

---

**From:** Haskin, Rita  
**Sent:** Tuesday, June 30, 2015 5:10 PM  
**To:** 'j.andre.clark@gmail.com'  
**Cc:** Board (@caltrain.com); cacsecretary (@caltrain.com); Caltrain, Bac (@caltrain.com)  
**Subject:** Re: bikes riding on sidewalk at Caltrain San Francisco (4th and King)

Good afternoon, Mr. Clark. Your message to the Caltrain Board of Directors, Caltrain Citizens Advisory Committee and Caltrain Bicycle Advisory Committee was referred to me for response. The Board members and committee members will receive a copy of our correspondence.

Thank you for letting us know about a potential pedestrian safety issue outside of our San Francisco station. I'm providing the information to our Director of Safety and to city staff.

The sidewalks around the station are city property and any bicycle-riding violations on them would be handled by the San Francisco Police Department. Our Transit Police unit focuses on issues on Caltrain property.

In response to your message, we've asked our station staff to remind customers to walk their bikes.

Sincerely,

Rita

**Rita P. Haskin**

SamTrans | Caltrain | TA  
Office of Customer Service and Marketing  
1250 San Carlos Ave.  
San Carlos, CA 94070-1306  
650-508-6248  
[www.smctd.com](http://www.smctd.com)

Consumer Report #060485

Jonathon Clark – [j.andre.clark@gmail.com](mailto:j.andre.clark@gmail.com)

Dear Caltrain Board, While you are contemplating bike spaces and bike parking, can you please also give some thought to pedestrian safety. I am a lifelong bicyclist who who walks past the 4th and King station at commute time on a regular basis. Every day there are probably hundreds of bikes riding on the sidewalks, swerving in an out of pedestrians. This is just unacceptable. It's high time to start issuing tickets for this illegal and dangerous behavior. Of course there is always the refrain "no budget to do so" but the ticket revenue would far outweigh the cost of overtime. Thanks for your consideration,

## McKenna, Nancy

---

**From:** Ihaveajob <ihaveajob@gmail.com>  
**Sent:** Tuesday, June 30, 2015 5:01 PM  
**To:** Board (@caltrain.com); cacsecretary (@caltrain.com); Caltrain, Bac (@caltrain.com)  
**Cc:** janice@sfbike.org; bikesonboard@sfbike.org  
**Subject:** Supporting More Bike Space On Caltrain

Hello, I would like to voice my support for as much bike space as possible in all future Caltrain cars. In the current system, the Bombardier model, with its limited bike capacity, is a serious hindrance to bike commuters like myself. Every May, following bike-to-work day, lots of people start biking to work on a regular basis, only to become discouraged when they get bumped out of rush hour trains on their way home. Ensuring a generous, predictable bike riding capacity will do a lot of good to the health and livability of the Bay Area in general, and bike commuters in particular.

Thanks for your attention.

--

-Pablo Diaz-Gutierrez

## McKenna, Nancy

---

**From:** Sergey Stavisky <sergey.stavisky@stanford.edu>  
**Sent:** Tuesday, June 30, 2015 4:50 PM  
**To:** Board (@caltrain.com); cacsecretary (@caltrain.com); Caltrain, Bac (@caltrain.com)  
**Cc:** janice@sfbike.org; bikesonboard@sfbike.org  
**Subject:** I Support More Bike Space On Board and More Bike Parking for Caltrain

Hi,

As a daily commuter between San Francisco and Palo Alto, I strongly support CalTrain becoming more accommodating to bikers. I've had to switch to an electric skateboard rather than bicycle because I was tired of getting bumped, but I recognize that this is an expensive/dangerous switch that most people can't make. Accommodating bikes allows people to commute from further away, in an environmentally friendly manner. Please help ease the Bay Area's congestion and improve quality of life with a safe, convenient way to incorporate bicycling into one's commute.

Thank you,  
Sergey Stavisky

## McKenna, Nancy

---

**From:** Alyson Jacks <alysonjacks@gmail.com>  
**Sent:** Tuesday, June 30, 2015 4:46 PM  
**To:** Board (@caltrain.com); cacsecretary (@caltrain.com); Caltrain, Bac (@caltrain.com)  
**Cc:** janice@sfbike.org; bikesonboard@sfbike.org  
**Subject:** I Support More Bike Space On Board and More Bike Parking for Caltrain

To the Caltrain Board of Directors:

I join the San Francisco Bicycle Coalition and strongly encourage the JPB to take the following suggestions into account to ensure that Caltrain continues to serve all riders:

- Set a transit agency goal that a minimum of 20% of passengers will access Caltrain by bike by 2020;
- Provide bike capacity for at least 16% of Caltrain passengers, or approximately a 6:1 seat- to-bike space ratio;
- Allocate and invest significant resources, including funding, staff time and station space, to develop robust bike parking facilities and plan for the integration of the upcoming bike share expansion;
- Ensure the most accessible platform and car design as possible for all passengers, including seniors, children, people with disabilities and people bringing bicycles onboard.

Ανδ τηανκ ψου φορ ρεχομμενδινγ α σιγνιφιχαντ Ξ3 μιλλιον ινπεστμεντ ιν σεχυρε βικε παρκινγ. Ι ενχου ραγε τηε Βοαρδ το αππροπε τηισ ρεχομμενδατιον.

Αλυσον θαχκσ

ΣΦ Βικε Χοαλιτιον Μεμβερ

Sent from my iPad

## McKenna, Nancy

---

**From:** Dan Priestley <dwpriest@gmail.com>  
**Sent:** Tuesday, June 30, 2015 4:38 PM  
**To:** Board (@caltrain.com)  
**Cc:** bikesonboard@sfbike.org; Nabong, Sarah; Murphy, Seamus; cacsecretary (@caltrain.com); Caltrain, Bac (@caltrain.com)  
**Subject:** Increased bike capacity on electrified trains

To whom it may concern-

I strongly support increasing bike capacity on the electrified trains that are planned for a 2020 roll-out. Allowing more bikes on the train will increase the radius of people who can use Caltrain without driving to/from the stations. While public transit is an option at some stops, the connection networks don't support everyone's needs and bicycles can fill in those caps. In addition, having more riders bike to/from Caltrain stations will decrease parking, traffic congestion, and pollution.

The biking routes in the cities on the Caltrain corridor continue to support better biking infrastructure like dedicated bike lanes. Increasing bike capacity on the trains helps complete the transportation puzzle. Please overrule the staff's recommendation of keeping capacity at 11% and increase bike capacity to allow at least 16%, preferably 20% of passengers to bring bikes onboard electrified trains in 2020.

Thank you

-Dan

Redwood City



## McKenna, Nancy

---

**From:** Hilary Noll <hilaryn@firsthousing.org>  
**Sent:** Tuesday, June 30, 2015 4:37 PM  
**To:** Board (@caltrain.com); cacsecretary (@caltrain.com); Caltrain, Bac (@caltrain.com)  
**Cc:** janice@sfbike.org; bikesonboard@sfbike.org  
**Subject:** I Support More Bike Space On Board and More Bike Parking for Caltrain

Hi,

I bike from Marin County to the San Francisco 4<sup>th</sup> and King Caltrain station for my weekly commute south to downtown San Jose and depend on the wonderful Caltrain Bike Car. It's a wonderful way to commute!

I'm writing to urge the Caltrain Board to pass a design that provides bike capacity for at least 16 percent of Caltrain passengers. Please support the transit agency making it an official goal that at least 20 percent of Caltrain passengers will access the system by bike by 2020.

Finally, I want to thank Caltrain staff for recommending a significant \$3 million investment in secure bike parking and encourage the Board to approve this recommendation.

Best,

**Hilary Noll**, Assoc. AIA, LEED AP BD+C  
Project Manager | Enterprise Rose Architectural Fellow

**First Community Housing**

75 East Santa Clara St. Suite 1300 | San Jose, CA 95113

o: 408.291.8650 x24 | c: 505.720.0030

e: [hilaryn@firsthousing.org](mailto:hilaryn@firsthousing.org)

[Website](#) [Facebook](#) [LinkedIn](#)

[www.rosefellowship.org](http://www.rosefellowship.org)

## McKenna, Nancy

---

**From:** Fisher-Sanders, Leslie <lfishersanders@presidiotrust.gov>  
**Sent:** Tuesday, June 30, 2015 4:28 PM  
**To:** Board (@caltrain.com); cacsecretary (@caltrain.com); Caltrain, Bac (@caltrain.com)  
**Cc:** janice@sfbike.org; kesonboard@sfbike.org  
**Subject:** I Support More Bike Space On Board and More Bike Parking for Caltrain

Hi,

I highly support as much room for bikes as possible on trains and in walk spaces to get to the trains. I am a cyclist and it is much easier to travel by bike when there is enough designated room for me to stand with my bike.

Safe bike parking would also make commuting less stressful.

I like the option to take my bike with me when travelling so I hope the secure bike parking can be an addition to more room on the trains for an overall greater cyclist accessibility.

Thank you

Leslie

## McKenna, Nancy

---

**From:** Lyle <lyle.sweeney@gmail.com>  
**Sent:** Tuesday, June 30, 2015 4:21 PM  
**To:** Board (@caltrain.com); cacsecretary (@caltrain.com); Caltrain, Bac (@caltrain.com)  
**Cc:** janice@sfbike.org; bikesonboard@sfbike.org  
**Subject:** I Support More Bike Space On Board and More Bike Parking for Caltrain

Please think and plan for the future. Bikes, Trains and Buses are not mutually exclusive.

Too many times I have been left on a train platform because there was no room for my bike.

- Add bike capacity for Caltrain passengers so no one is left standing at a platform. Is that 20% is that more?
- How can Caltrain move more people and their bikes into the future 2020 and beyond?

Thank you for your accomplishments to date. My first ride on Caltrain had no room for bikes. Let's do more!

--

Lyle Sweeney  
San Francisco, CA

## McKenna, Nancy

---

**From:** Chris Andree <andree.christopher@gmail.com>  
**Sent:** Tuesday, June 30, 2015 3:47 PM  
**To:** Board (@caltrain.com); cacsecretary (@caltrain.com); Caltrain, Bac (@caltrain.com)  
**Cc:** janice@sfbike.org; bikesonboard@sfbike.org  
**Subject:** Caltrain Bike Space and Parking Area

Hello,

I applaud what you at Caltrain have done for bike access, and want to encourage you to keep pushing further in the new train designs. With more and more bikers, our roads are gathering safety in numbers.

I hope that you can accommodate bikers who want or need to bike on either end of their Caltrain trip, as we need a boost in capacity and suggestion for others to join in sustainable commuting.

Thank you,

Chris Andree  
Oakland, CA

## McKenna, Nancy

---

**From:** Emma Shlaes <emma@bikesiliconvalley.org>  
**Sent:** Tuesday, June 30, 2015 3:22 PM  
**To:** Board (@caltrain.com); Caltrain, Bac (@caltrain.com); Fromson, Casey; Murphy, Seamus; Petty, Sebastian; Simon, Mark  
**Cc:** Shiloh Ballard; Colin Heyne  
**Subject:** Caltrain EMU procurement  
**Attachments:** 150630 SVBC Caltrain petition signatures.pdf

Dear Honorable Caltrain Joint Powers Board members,

Please see attached for a petition with 138 signatures solicited by the Silicon Valley Bicycle Coalition (SVBC), a member-based non-profit with the mission to create a healthy community, environment, and economy through bicycling for people who live, work, or play in San Mateo and Santa Clara Counties. This petition was open from June 18 - present on our website.

We will continue collecting signatures leading up to Thursday's JPB meeting, however, we wanted to share the total now to include in the materials before that meeting. You will find in the document the five recommendations of SVBC regarding the future of Caltrain and bicycles.

Please let me know if you have any questions.

Thank you,  
Emma

--

Emma Shlaes  
Policy Manager  
Silicon Valley Bicycle Coalition  
96 N. Third Street, Suite 375  
PO Box 1927  
San Jose, CA 95109  
Office: 408-287-7259 Ext. 228  
Cell: 650-703-1191  
<http://bikesiliconvalley.org>

Summer Membership Drive: [Support Biking in Silicon Valley and Win Quakes, Jazz Fest Tix and More!](#)



**ACTION ALERT**

June 30, 2015

Dear Honorable Caltrain Joint Power Board of Directors:

Thank you for your longtime support of bikes on Caltrain. As someone who uses a bike to access Caltrain, I urge you to maintain on-board bike capacity on electrified trains as well as dedicate funding to implement secure biking parking at all Caltrain stations. Biking to stations is a cost-effective, environmentally friendly, and healthy transportation option for all passengers and should be encouraged. In particular, I support Silicon Valley Bicycle Coalition (SVBC)'s recommendations:

1. Set mode share goals for access to stations that provide for at least 20% of passengers to access Caltrain stations by bike.
2. Provide on-board bike capacity for at least 16% of Caltrain passengers.
3. Commit to a robust financial commitment for secure and attractive wayside bike parking facilities at Caltrain stations.
4. Support the use of bike share systems that provide convenient first and last mile access to and from Caltrain stations.
5. Ensure the most accessible platform and car design as possible for all passengers.

Sincerely,

	First Name	Last Name	Zip	State	Comment	Date signed
1	Emma	Shlaes	94103	CA	I ride Caltrain every day with my bike and right now the bike parking and bike share are not good options for me. Please develop better bike parking facilities!	6/18/15 18:49
2	George	Koch	95051	CA	We need much more accommodation for bicycles on trains and more storage at stations!!	6/19/15 14:26
3	Gavin	Powell	95050	CA		6/20/15 16:03
4	Eric	Nordman	94301	CA	Luckily the routes I use typically have enough bike capacity but I am well aware of others who are often bumped.	6/21/15 14:03
5	Carlo	Velazquez	95126	CA		6/22/15 12:15
6	Steve	Sergeant	95132	CA	I've been bumped at least once each month from evening trains departing San Francisco, and even from morning trains leaving Diridon. I've (re-) injured a shoulder lifting my bike off of the Gallery car trains due to their steep staircases. I avoid using 22nd St. station because of the stairs, and instead I ride back to 4th St. late in the evening.	6/22/15 16:08



## ACTION ALERT

7	Cliff	Bargar	94107	CA	I work in Sunnyvale bring my bike on the train 1-3 days/week so that I can get around Sunnyvale during the day or somewhere else on the peninsula or in the city after work. Because I usually board the train at 4th and King or Lawrence I have yet to be bumped but I can see how it would be incredibly inconvenient and would disincentivize people from making the more environmentally-conscious (not to mention economically and community-friendly) choice of biking instead of driving	6/22/15 16:13
8	Greg	Macway	94061	CA	I live in Redwood City, work in SF and bike 5 days a week. I've been regularly bumped this summer because of lack of space or over-policing by conductors. Bike parking is not an option as I use my bike on both ends of my commute. More space for bikes please!	6/22/15 16:18
9	Lola	Torney	95112	CA	Luckily the routes or times I use typically have enough bike capacity, but I am well aware of others who are often bumped.	6/22/15 16:26
10	Richard	Thomas	94043	CA		6/22/15 16:33
11	Shweta	Immel	94061	CA	- I get bumped at Redwood city NB #319 train in the morning atleast 8 to 10 times a month because the Bike car is full. - The bike cars are very crowded and most seats are taken by passengers without bikes. So i get no place to sit or even stand near my bike.	06/22/2015 16:33
12	Mark	Hirsch	95132	CA	Means I cannot commute to San Francisco if there is no space	6/22/15 16:40
13	K	Sveinsson	95126	CA	I commute every day from San Jose to San Francisco and need my bike on both ends; however, I would be willing to pay extra to bring my bike on board if I was guaranteed both a spot for my bicycle and that non-riders were excluded from the bike cars. Moving forward, we need a balance of truly secure bike parking at all stations, the ability to bring bikes on the train and bike rentals. More and more people will be living and working near these stations, so the demand for bike parking and access will only increase. Thank you for seeking our input.	6/22/15 16:44
14	Lauren	Renaud	95125	CA	I bring my bike every day. If I were not able to, it would be difficult for me to get to my work that's 2 miles away from the station.	6/22/15 17:09
15	Alana	rivadenevra	95126	CA	I bring my bike on board.	6/22/15 17:15

## ACTION ALERT

16	Melissa	Burroughs	95110	CA	I ride the train from San Jose to Palo Alto everyday and need my bike at both ends. If I weren't allowed to bring my bike on the train I would be forced to drive. I typically get bumped a few times each summer but I'm lucky compared to many other cyclists that ride during more peak times. I'm also lucky enough to board the train at stops that are either at the beginning of the line (San Jose) or where a lot of bikes get off (Palo Alto) but others aren't so lucky. I would be happy to pay extra assuming both my bike and myself had a place to park. This means that non-cyclists would not be allowed to sit in the bike car (which is a source of constant frustration currently, but there's not much that can be done).	6/22/15 17:57
17	Moema	Gondim	95125	CA		6/22/15 18:00
18	Sami	Laine	95014	CA	I use Caltrain bike parking in Sunnyvale, keeping this available and affordable is critical for my commute. I need to bring bike on train periodically and the current capacity is often at maximum - been bumped from SF before. Just today on NB217 many riders were being denied access at several stations up the peninsula. More capacity at morning and afternoon peaks is desperately needed.	6/22/15 18:20
19	Cindy	Moreno	95110	CA	I commute everyday and my livelihood depends on having efficient and dependable bike access.	6/22/15 19:32
20	Earl	Miller	94041	CA	Bike quew full	6/22/15 19:50
21	Jon	Smith	95110	CA	The inability to ride to and from Caltrain would cause me to question the viability of commuting via Caltrain	6/22/15 21:09
22	Geoffrey	Hatchard	95116	CA	As Caltrain becomes more and more popular, the need to speed up getting bicycles on and off the trains will be paramount. Do what you can to get level-loading trains so we can help speed up the process.	6/22/15 22:17
23	Parth	sethia	94085	CA	Taking the train from Sunnyvale to San Fran. Running into full cars with not enough capacity	6/22/15 23:39
24	Michael	Egger	95046	CA		6/23/15 0:41
25	stepan	shurygin	95112	CA	So many times ive nearly fallen off the stupid tall train stairs trying to bring my bike up with cleats on my shoes. 2. So many times ive seen people turned away from bringing bikes on caltrain during rushhour because the way they are placed within train cars is idiotic. Shoudl be vertical up/down on wall instead of stacked up on the floor. 3. So many times I have seen people miss their stop because theyre scrambling to undo 5 bikes to get to their bike at the bottom while pulling into a station. Your seat tag system is kind of a	6/23/15 0:43





## ACTION ALERT

					lame hack.	
26	Kathleen	aldrige	95436	CA	I would like to see more access to Caltrains with Bikes. Allowing this will help support efforts to reduce our oil consumption and increase bikers fun!!	6/23/15 8:31
27	Jennifer	Mathis	95131	CA		6/23/15 9:26
28	Carmen	Lynaugh	95008	CA	my friends that use it tell me security is an issue and bikes are stolen!! This is unacceptable!! With the need to get more people on alternative transportation modes Caltrans needs to be a partner to the solution not an obstacle!! Need to make access easier and more secure to encourage use by bicyclists.	6/23/15 10:07
29	Farrin	Abbott	94063	CA	I take my bike on Caltrain to work & home. It makes a huge difference in my stress, health and happiness! The trains are too tall for easy bicycle loading. Much easier in Chicago.	6/23/15 10:34
30	Kristal	Caidoy	95035	CA	Location, business, connectivity and time impact my bike access to caltrain.	6/23/15 11:30
31	chris	atkinson	94301	CA	when there are too many bikes on the train and people get bumped thats the worst thing to happen	6/23/15 23:52
32	Mark	Eliot	94403	CA	I ride Caltrain daily during the work weed and have been denied boarding many times this year. Reliable bikes-on-board access is hugely important to me.	6/24/15 14:29
33	Max	Sadrieh	95110	CA		6/24/15 14:31
34	Andrea	Corredor	95110	CA		6/24/15 14:37
35	Ian	Bruce	95112	CA	I use my bike during my commute to get to and from the caltrain.	6/24/15 14:42
36	Jaime	Fearer	95116	CA		6/24/15 15:23
37	Peter	Black	94062	CA	I often bike to caltrain and ride to the city and back to RWC. Getting bumped is no fun when your wife is 9 months pregnant and dealing with two kids under 5.	6/24/15 16:14



## ACTION ALERT

38	Lloyd	Cha	95070	CA	I frequently use Caltrain to visit San Francisco from San Jose. I've experienced bumps that have separated me from my fellow travelers, including one time I was bumped when my young children were already on the train with their bicycles.	6/25/15 0:21
39	Thomas	Greene	94062	CA		6/25/15 17:34
40	Lindsay	Joye	94306	CA	Use bikes and Caltrain between SF & Palo Alto	6/25/15 17:38
41	Jeff	Peters	95112	CA	I CalTrain from San Jose to Palo Alto all weekdays and need my bike on both ends. I get to the train at least 10 minutes early to avoid full bike cars. Daily, cyclists are turned away at Mountainview and Palo Alto due to overcrowding.	6/25/15 17:43
42	Nicholas	Zello	95112	CA	I would like to use Caltrain for my commute from SJ to Palo Alto, but find the challenges with using my bike at either end to be enough of a problem that I opt to drive instead.	6/25/15 17:44
43	Aron	Mason	94403	CA	I am frequently bumped from southbound trains when trying to get on at Hillsdale in the morning.	6/25/15 17:48
44	pierre	willard	94306	CA	Usually I go twice a week to SF from Cal station, with my bike, always taking one of the Gallery car trains. On the way to SF, the bike cars get really full (especially on Mondays) and it's quite often that people waiting on the last stations before 4th and King are bumped. Similarly, one the way back, the bike cars are completely full leaving SF. This proves that even 80 bike space is no longer enough !	6/25/15 17:49
45	Blake	Malcolm	95008	CA	I ride the train 2x a week with my bike and 75% of the time I have to wait for the next train because there is no more room for bikes	6/25/15 17:53
46	John	Blaine	95032	CA	Saves me Taxes, Time, reduces congestion	6/25/15 17:55
47	Wayne	Krill	94087	CA	I am a user of bike access at various stations and rely on availability for my transportation needs as I don't own other transportation than bicycle.	6/25/15 17:55
48	sonal	gupta	94305	CA	I will soon begin work in SJ and plan to bike to and from caltrain stations. I worry about the limited bike capacity on caltrains. Many of my friends who commute by caltrain frequently complain about it.	6/25/15 17:58
49	Colin	Buckner	95050	CA	I commute daily by bike from SJ to Palo Alto, and rarely have a place to sit because the bike cars are so packed. We need MORE bike space and stricter enforcement of bike car seating only being for cyclists!	6/25/15 17:58



## ACTION ALERT

50	Kraig	Kurucz	94062	CA	Afternoon trains are hard to get a bike on and off. Also conductors don't ask non bike people to use the other door. So bikers have to wait for them to enter before even starting to get in. Then conductors rush the bikers to get the doors closed	6/25/15 18:05
51	Erik	Ganswindt	95128	CA	Bike/Train to SF on weekends	6/25/15 18:07
52	REBECCA	THOMSON	94402	CA	It is not easy for a middle-aged person to get a bike onto the train. Also, not easy to find space, so bike-sharing would be an incredible solution for me as well as many others.	6/25/15 18:10
53	Sam	Dicker	94114	CA		6/25/15 18:19
54	David	Guinther	95112	CA	We use caltrain for non-profit meetings in San Francisco. Farmers markets along the tracks are another reason. We also frequent San Francisco and palo alto from San Jose for recreational rides. Thanks in advance for your continued support for improved bike cars as well as more bike share stations. Dave g	6/25/15 18:19
55	Candace	Connell	95051	CA		6/25/15 18:21
56	Ron	Twist	95124	CA	Riding between SJ and SF I typically get on the train early enough to avoid getting bumped but its a very serious issue, particularly during peak commute hours. When you're trying to keep your day adherent to a particular schedule with a very limited amount of time allotted for personal travel time, being forced to wait an additional hour can make or break a day. If possible, perhaps experiment with a schedule allowing additional, smaller trains to leave at half-past the hour during those peak commute times. Best of luck!	6/25/15 18:22
57	John	Thomson	94086	CA	My commute completely relies on being able to carry my bike on the train, which is often quite full.	6/25/15 18:23
58	Rushang	Mehta	95121	CA	Hard to get a spot on train during rush hours, got bumped couple of times. I don't use it everyday, but do end up using it several times a month.	6/25/15 18:23
59	Greg	Coombe	94041	CA	Once a month or so, I commute from Mountain View to SF for work. I haven't quite figured out the right times to ride, so I get bumped about 25% of the time. Not fun.	6/25/15 18:27
60	Anne	Barnet	94304	CA		6/25/15 18:33
61	janet	knapp	95112	CA	Less auto pollution around stations	6/25/15 18:34
62	RUFUS	ACOSTA	95112	CA	Since I live car-free, any improvement or increase in access to bicycles is very much welcomed.	6/25/15 18:35



## ACTION ALERT

63	Ashok	Elluswamy	94041	CA	My wife takes the train everyday and almost 90% of the days she is not let into the train due to a full bike cart. It is very frustrating and does not encourage Caltrain usage.	6/25/15 18:40
64	Nivetha	Purusothaman	94041	CA		6/25/15 18:50
65	Joseph	Kaye	94041	CA	It makes a huge difference in my Mountain View-4th & King commute.	6/25/15 18:57
66	Philip	Pines	94306	CA	I commute to SLAC by bike during the week and enjoy biking excursions by train with bike on weekends	6/25/15 19:18
67	George	Lopez	95126	CA	I tend to reluctant because the cars are full or limited number of access.	6/25/15 19:51
68	Carol	Avina	95129	CA	Healthy commute for friends. Ride to train, take train to stop near work, ride to work. And visa versa.	6/25/15 19:51
69	Richard	Swent	94303	CA	I take Caltrain from Palo Alto to San Jose with my bike regularly. Without my bike it would take me much longer to get to my final destination, since it is too far to walk and the light rail schedule doesn't sync well with Caltrain.	6/25/15 20:24
70	Melissa	Maigler	94404	CA		6/25/15 20:25
71	Maggie	Burgett	94041	CA	Bike cars are crowded and inefficient. Bikes could be stored vertically to make on off quick and efficient. Riders without bikes should only enter passenger only cars.	6/25/15 20:40
72	Barry	Marchessault	94066	CA		6/25/15 20:57
73	Gregory	Smith	94025	CA	Getting a bike on and off the train can be frustrating. Especially for the older cars with the stairs (which ironically are the only ones that can fit a reasonable number of bikes). Add to that full bike cars meaning you are forced to miss a train? ugh! This deters many people I know from both biking and riding the train. They'd have a 30 minute walk each way at the other end. Not going to happen. It means another car is clogging our roads and you do not get revenue.	6/25/15 21:11
74	Roberto	Perelman	94087	CA	Can't bike to Caltrain because there is no secure bike parking (I don't need my bike at the other end of my trip).	6/25/15 21:13
75	Mark	Hoag	95050	CA	Have the ability to store bikes vertically for faster & easier accessibility	6/25/15 21:25
76	Simon	Tunbridge	94109	CA	I have been bumped/not allowed on to the train several times in the past with my bike in the mornings on the way to work, having less capacity looks shortsighted and will only worsen the problem.	6/25/15 21:30
77	Walt	Brown	95033	CA	BIKING TO SAN FRANCISCO FROM SAN JOSE...	6/25/15 22:03



## ACTION ALERT

78	Barton	Coddington	95003	CA	taking the 17 flyer for Santa Cruz allows me access to San Francisco and all points in between.	6/25/15 22:19
79	Max	Howard	95136	CA	When I ride the train I take my bike with me.	6/25/15 23:04
80	Maddy	McBirney	94023	CA	Both Stations and trains	6/25/15 23:12
81	Markus	Brockmann	95014	CA		6/25/15 23:16
82	Romel	Jacinto	94110	CA		6/25/15 23:30
83	Paul	Bonifacio	94303	CA		6/25/15 23:38
84	Joshua	Mooney	94401	CA		6/26/15 0:04
85	Cheryl	Smith	94043	CA	I live very near a station and use my bike constantly to expand my travel scope. thank for considering bikes!	6/26/15 0:48
86	Javier	Garza	94404	CA	Please consider bike capacity, it is really disappointing to be left out at the station. It also be great if you guys come across a way of organizing bikes better within the train cars.	6/26/15 1:07
87	Scott	McMahon	94025	CA	Bike on train is so much more efficient. It can cut end to end trip time by half or more. Without being able to bring my bike on board, many trips are not worth doing on Caltrain.	6/26/15 1:17
88	Pat	da Costa	94024	CA		6/26/15 1:44
89	cheryl	Longinotti	94925	CA	I use Caltrain to visit family and friends on the Peninsula.	6/26/15 1:56
90	Scott	Chong	94002	CA	I ride my bike from Caltrain to work	6/26/15 2:23
91	Morgan	Gerhart	95008	CA	I commute via Caltrain with a bike 3-4 days week.	6/26/15 3:56
92	Diane	Brandt	94025	CA	I have low confidence there will be available space during commute hours. I'd like to be able to take a train anywhere and know my bike will have room.	6/26/15 8:13
93	Deborah	Esters	94115	CA	Hi Ride SF-Lawrence. I notice that the #375 Baby Bullet skips Lawrence but stops at Hillsdale. the #277 (5:39) gets about 75 riders daily, maybe 30 bikes. It would be helpful if the 375 stopped at Lawrence and if need be skipped Hillsdale so that it would service the very busy station ans skip the less busy one.	6/26/15 10:36
94	Bruce	Storms	94062	CA	On the Caltrain bike cars, I have experiences overcrowding sometimes leading inability to board the train.	6/26/15 11:27
95	Erica	Stanojevic	95060	CA		6/26/15 14:07
96	James	McKee	94040	CA		6/26/15



## ACTION ALERT

						16:20
97	Tammy	Bigelow	94085	CA	I take my bike on Caltrain at least 3 times a week, and want to make sure bicyclists aren't bumped off due to capacity issues.	6/26/15 17:52
98	Shailendra	Rao	94107	CA	I take caltrain everyday and getting the bike in and out is pain. Also we need more space for bike racks if the trains are full we are not allowed in..	6/26/15 18:15
99	Bob	Sims	94043	CA	I have limited ability to drive and to walk (hips). The Caltrain bike cars have enabled me to travel from Mtn View to San Jose and San Francisco, then cycle to my final destinations. It is critical for my mobility to have this option.	6/26/15 19:01
100	Vivian	DiSano	94066	CA	I use the train to go home from work M-F 21 miles	6/26/15 22:51
101	Brandon	Tinianov	95050	CA	Bike access allows me to easily commute to my San Francisco sattelite office at 945 Front Street multiple times a week. Without the combination of BOTH train and bike access, such a commute would be impractical or even impossible.	6/27/15 0:40
102	Leslie	Stepanek	94086	CA	Concerned about enough bike room at sunnyvale station going north in AM.	6/27/15 7:35
103	Joe	Dumas	95136	CA		6/27/15 9:32
104	Ewen	Denney	95136	CA	I use Caltrain/bike every day to get to work.	6/28/15 10:34
105	Jeffrey	Tong	94066	CA	Bicycle + BART / Caltrain / Bus go hand-in-hand. Mass-transit will not relieve auto congestion unless they accommodate bicycles.	6/28/15 17:50
106	Dan	Ignosci	92672	CA	Not enough bike facility on board trains and secure storage at stations	6/29/15 14:58
107	Danielle	Glaser	94043	CA	Been bumped multiple times traveling from Mountain View to SF.	6/29/15 15:06
108	Mardhen	Bravo	94401	CA	Bombardier cars carry less cars than the Nippon Sharyo models.	6/29/15 15:11
109	Jennifer	Gile	94403	CA	Please consider equal bike access across the trains: the more popular Bombardier styles have such limited bike capacity and are often the express trains.	6/29/15 15:19
110	Richard	Masoner	95066	CA	I often use Caltrain from San Jose for destinations on the Peninsula. Continued support for bike access is vital for my regional transportation.	6/29/15 15:51
111	Aaron	Francis	95125	CA		6/29/15 16:23
112	ilya	moskovko	95008	CA	i use caltrain all the time but hesitant to bring my bike knowing how often bikes get bumped off of train	6/29/15 17:16



## ACTION ALERT

113	Nicole	Belle Isle	94611	CA	I take Caltrain back and forth from Menlo Park to SF about once a week for work. It is stressful finding a bike space on the train and a seat nearby so I can keep an eye on my bike, especially during rush hour, because the bike cars are often filled to capacity.	6/29/15 19:15
114	Kevin	George	95116	CA	I have hesitated to take my bike on the train because I don't want to get bumped. For that reason I don't mix bike and Caltrain rides, though I do take Caltrain on occasion. My primary mode of commute transportation is by bike.	6/29/15 23:06
115	Matthew	VanOosten	95112	CA	I love taking my bike on Caltrain and am thankful I get on at San Jose because there is still space in the bike car. Mid-peninsula stops are not so lucky. More space for bikes on Caltrain is desperately needed. Thanks	6/30/15 0:25
116	Maryanne	Mlls	95125	CA		6/30/15 0:28
117	Wayne	Smith	95112	CA	There is often not enough room to get bike on the trains. Have sometimes had to wait for up to two trains to be able to get home	6/30/15 0:43
118	Dan	Ponce	92117	CA		6/30/15 0:52
119	Virginia	Thomas	95030	CA		6/30/15 0:58
120	Alyssa	Plicka	95033	CA		6/30/15 1:00
121	Emily	Lam	94403	CA	I need to take my bike on Caltrain to make it to my office in a timely manner because the light rail is so slow. Often times the cars cannot take anymore bikes in the peninsula because they are full. So I get discouraged from being left behind and don't take the train as often as I would if there were more parking. Most of the time the bikes almost empty out at Palo Alto but that doesn't help me getting on from hillsdale.	6/30/15 1:02
122	stepan	shurygin	95112	CA	Had my wheel stolen at Diridon corals last year Watched people be unable to get on the train because it was full this year	6/30/15 2:07
123	Galen	Rosenberg	94025	CA	I use the bike train multiple times per week to get to work	6/30/15 3:59
124	Allen	Levin	94539	CA	I use Caltrain 3-4 times per week. If bike capacity were to drop or fewer trains were to run it would take much longer to get to the South Bay.	6/30/15 8:49
125	Carmen	Lynaugh	95008	CA	I am personally not impacted however I have heard stories from coworkers that use Caltrain that say the parking on the train is not as secure as it could be and more bike parking would be better.	6/30/15 9:36



## ACTION ALERT

126	Jonathan	Schuppert	95110	CA	I commute using Caltrain for meetings on occasion. This doesn't impact me daily like so many commuters, but I've heard stories of people getting bumped. I have not had that issue in the past but I also try to plan my trip to avoid the prime trains, which isn't always doable.	6/30/15 10:25
127	Aaron	Barkhouse	94025	CA		6/30/15 12:00
128	Marco	Velasco	95116	CA	More space is definitely needed, more and more people are using bikes. The bike cars also need to be dedicated to people on bikes, many people take up the seats that do not have bikes.	6/30/15 12:13
129	K	Lee	94301	CA	Afraid to use Caltrain because of bumping from trains and unsafe bicycle parking at California Ave train station.	6/30/15 12:14
130	Erin	Allred	94061	CA	The bike cars are regularly full on morning Caltrains which is incredibly inconvenient if you are waiting at the station with your bike.	6/30/15 12:20
131	Anna	Ostberg	95125	CA	I bring my bike on Caltrain a couple of times per month. Space for bikes can be a problem on Bombardier cars even in off hours. Secure bike storage at stations would be a great improvement.	6/30/15 13:08
132	Brett	Holcomb	95125	CA	I ride from San Jose to Menlo Park and so far have only been left standing at the station once. I worry that as more people discover biking is less stressful than driving in traffic we'll have more and more bumps.	6/30/15 13:18
133	Tony	Nguyen	95132	CA	Biking and CalTrain is becoming more stressful than driving.	6/30/15 13:49
134	Alison	Paulin	95128	CA		6/30/15 14:23
135	Gino	Ledesma	95014	CA	I commute by bike so there's one less car on the road. Getting bumped because there's no space makes for a very frustrating experience, and sometimes ends up becoming a frustrated driver on the road.	6/30/15 14:25
136	Aarthi	Rayapura	94025	CA	I Caltrain + Bike to work.	6/30/15 14:44
137	Yakau	Yermalitski	94040	CA		6/30/15 15:36
138	Jeff	Thomas	94117	CA		6/30/15 17:13



**McKenna, Nancy**

---

**From:** Malin Sicking <mapalipin@gmail.com>  
**Sent:** Tuesday, June 30, 2015 3:08 PM  
**To:** Board (@caltrain.com); cacsecretary (@caltrain.com); Caltrain, Bac (@caltrain.com)  
**Cc:** janice@sfbike.org; bikesonboard@sfbike.org  
**Subject:** I Support More Bike Space On Board and More Bike Parking for Caltrain

Please vote for a bike friendly system!

## McKenna, Nancy

---

**From:** Lois <loiskell@yahoo.com>  
**Sent:** Tuesday, June 30, 2015 3:08 PM  
**To:** Board (@caltrain.com); cacsecretary (@caltrain.com); Caltrain, Bac (@caltrain.com)  
**Cc:** janice@sfbike.org; bikesonboard@sfbike.org  
**Subject:** I Support More Bike Space On Board and More Bike Parking for Caltrain

Bike commuters frequently get turned away from the Caltrain and this is unacceptable. It makes Caltrain an unreliable form of transportation for us. You need to solve this problem by increasing space for bikes on Caltrain in a big way, especially during commute hours. Stop treating bike commuters like second class citizens! Caltrain is supposed to be providing service to ALL riders, even those of us with bikes!

Very sincerely  
Lois Kellerman

## McKenna, Nancy

---

**From:** Erin Boyle <erin.s.boyle@gmail.com>  
**Sent:** Tuesday, June 30, 2015 3:01 PM  
**To:** Board (@caltrain.com); cacsecretary (@caltrain.com); Caltrain, Bac (@caltrain.com)  
**Cc:** janice@sfbike.org; bikesonboard@sfbike.org  
**Subject:** I Support More Bike Space On Board and More Bike Parking for Caltrain

Hi!

I'm writing to voice my ENTHUSIASTIC support for SFBC's suggested upgrades to the Caltrain -- especially that which expands bike capacity to 16% of users. I commute from the downtown Caltrain station to California Avenue every day, and have experienced not being allowed on on the way home. Caltrain is a wonderful system but this is an enormous problem — my commute is already an hour and a half once you include the biking I do on each end of the trip. Adding waiting for a new train to that is really terrible, and makes me consider driving, something neither I nor the city's highways want!

I hope you follow through on every one of SFBC's thought-out opinions on the upgrades. Thanks!

Erin

**McKenna, Nancy**

---

**From:** Roberto De Almeida <roberto@dealmeida.net>  
**Sent:** Tuesday, June 30, 2015 2:58 PM  
**To:** Board (@caltrain.com); cacsecretary (@caltrain.com); Caltrain, Bac (@caltrain.com)  
**Cc:** janice@sfbike.org; bikesonboard@sfbike.org  
**Subject:** I Support More Bike Space On Board and More Bike Parking for Caltrain

Hi,

I'm writing to support more bike space on board of Caltrain trains, as well as more bike parking at Caltrain stations.

It is important for the Caltrain Board to pass a design that provides bike capacity for at least 16 percent of Caltrain passengers; with an official goal that at least 20 percent of Caltrain passengers will access the system by bike by 2020.

Thank you for recommending a significant \$3 million investment in secure bike parking. I encourage the Board to approve this recommendation.

Thank you,  
--Roberto

## McKenna, Nancy

---

**From:** Sara Lopez <saralopez29@gmail.com>  
**Sent:** Tuesday, June 30, 2015 2:57 PM  
**To:** Board (@caltrain.com); cacsecretary (@caltrain.com); Caltrain, Bac (@caltrain.com)  
**Subject:** In Support of the Bike-Friendly Caltrain Future

Hi There,

I'd like to share my support and interest in encouraging the Caltrain board to pass a design that accomodates at least 16% (but hopefully more - 20%, 25%!) of it's passengers for bike transit, as well as create safe bike parking systems at stations.

Thank you for committing the \$3M in funds to make Caltrain more bike friendly!

-Sara

**McKenna, Nancy**

---

**From:** Kaufman, Evan R. <ekaufman@summitpartners.com>  
**Sent:** Tuesday, June 30, 2015 2:40 PM  
**To:** Board (@caltrain.com); cacsecretary (@caltrain.com); Caltrain, Bac (@caltrain.com)  
**Cc:** janice@sfbike.org; bikesonboard@sfbike.org  
**Subject:** I Support More Bike Space On Board and More Bike Parking for Caltrain

I Urge the Caltrain Board to pass a design that provides bike capacity for at least 16 percent of Caltrain passengers.

~~~~~  
Evan R. Kaufman  
Summit Partners  
200 Middlefield Road, Suite 200  
Menlo Park, CA 94025

P: 650.614.6641  
F: 650.614.6741  
[ekaufman@summitpartners.com](mailto:ekaufman@summitpartners.com)  
[www.summitpartners.com](http://www.summitpartners.com)

~~~~~Confidentiality Disclaimer~~~~~

This electronic transmission (and any attached document) contains confidential information from Summit Partners, and is for the sole use of the individual or entity to whom it is addressed and may be privileged, confidential or exempt from disclosure under law. If you are not the intended recipient of this email, or the employee or agent responsible for delivering it to the intended recipient, you are hereby notified that any other dissemination, distribution or copying of this transmission is strictly prohibited. If you receive this message in error, please notify Summit Partners at [postmaster@summitpartners.com](mailto:postmaster@summitpartners.com) and destroy the attached message (and all attached documents) immediately. Thank you for your cooperation.

## McKenna, Nancy

---

**From:** Romel Jacinto <webstuff@techbandit.com>  
**Sent:** Tuesday, June 30, 2015 2:31 PM  
**To:** Board (@caltrain.com); cacsecretary (@caltrain.com); Caltrain, Bac (@caltrain.com)  
**Cc:** janice@sfbike.org; bikesonboard@sfbike.org  
**Subject:** I Support More Bike Space On Board and More Bike Parking for Caltrain

Dear Caltrain Board,

I'm writing to strongly encourage the following:

1. Pass a design that provides a bike capacity for 16% of Caltrain passengers.
2. Bike use on Caltrain continues to grow, but an official goal of at least 20% of Caltrain passengers by 2020 would be something to strive for.
3. Caltrain staff has done a great job to recommend a \$3 million investment for secure bike parking and I encourage you to approve this recommendation.

Thank you.

--

Romel Jacinto  
San Francisco

**McKenna, Nancy**

---

**From:** Peter Eckersley <peter.eckersley@gmail.com>  
**Sent:** Tuesday, June 30, 2015 2:29 PM  
**To:** Board (@caltrain.com); cacsecretary (@caltrain.com); Caltrain, Bac (@caltrain.com)  
**Subject:** Please adopt ambitious bike targets for Caltrain!

Because of the limited connectivity and slowness of transit at either end of Caltrain, for many trips the only practical way to use Caltrain is to bring a bike.

As Bay Area cities become more bike-friendly, I see many fellow riders reaching the same conclusion. Caltrain needs to be prepared to meet that growing demand for onboard bike capacity and parking!

--  
Peter



**McKenna, Nancy**

---

**From:** Corey Johns <0xbyte@gmail.com>  
**Sent:** Tuesday, June 30, 2015 2:21 PM  
**To:** Board (@caltrain.com); cacsecretary (@caltrain.com); Caltrain, Bac (@caltrain.com)  
**Cc:** janice@sfbike.org; bikesonboard@sfbike.org  
**Subject:** I Support More Bike Space On Board and More Bike Parking for Caltrain

## McKenna, Nancy

---

**From:** Kyla Farrell <kylafarrell@gmail.com>  
**Sent:** Tuesday, June 30, 2015 2:17 PM  
**To:** Board (@caltrain.com); cacsecretary (@caltrain.com); Caltrain, Bac (@caltrain.com)  
**Cc:** janice@sfbike.org; bikesonboard@sfbike.org  
**Subject:** I Support More Bike Space On Board and More Bike Parking for Caltrain

Good Afternoon,

I am writing to urge the Caltrain Board to pass a design for the new Caltrain car that provides bike capacity for at least 16 percent of Caltrain passengers, to support that Caltrain sets an official goal that at least 20 percent of Caltrain passengers will access the system by bike by 2020.

Thank you to Caltrain staff for recommending a significant \$3 million investment in secure bike parking. I encourage the Board to approve this recommendation.

Best,  
Kyla Farrell

## McKenna, Nancy

---

**From:** Diana Pray <dianapraysf@gmail.com>  
**Sent:** Tuesday, June 30, 2015 2:16 PM  
**To:** Board (@caltrain.com); cacsecretary (@caltrain.com); Caltrain, Bac (@caltrain.com)  
**Cc:** janice@sfbike.org; bikesonboard@sfbike.org  
**Subject:** I Support More Bike Space On Board and More Bike Parking for Caltrain

Hello, and thank you for making it SO EASY to bring a bike on to Caltrain!

I'm a recent bike commuter--just 15 months--and I am so because the Bay Area's transit agencies have been making it easier and easier for everyone to get around, whether on feet, two wheels, or four+.

I took my first Caltrain ride in May, and my first Caltrain ride +bike just a few weeks later. You see, though I've been a bike commuter within SF and often to Berkeley/Oakland for over a year, I've been carless for just 6 months. Caltrain made heading down the Peninsula a dream! So easy, so safe, so civilized. Thank you!

Would you please continue your great work as you decide on the design for the new Caltrain car? More and more people are biking (yay!). I urge that you please:

- make a design that provides bike capacity for at least 16% of each train's riders
- make it an official goal that by 2020, at least 20% of all Caltrain riders will access the system by bike
- approve Caltrain staff's wise and necessary \$3 million investment in secure bike parking

Thank you! I miss my little two-seater convertible, but nothing beats being able to get everywhere I need to go in the SF Bay Area in ways that enrich society and treasure our planet. Hooray for bikes + public transit!

Gratefully yours,  
Diana Pray

## McKenna, Nancy

---

**From:** Kora Anzellotti <kanzellotti@linkedin.com>  
**Sent:** Tuesday, June 30, 2015 2:14 PM  
**To:** Board (@caltrain.com); cacsecretary (@caltrain.com); Caltrain, Bac (@caltrain.com)  
**Cc:** janice@sfbike.org; bikesonboard@sfbike.org  
**Subject:** I Support More Bike Space On Board and More Bike Parking for Caltrain

Hello Caltrain Board,

I'm a recent daily biker on Caltrain and in my short two months of daily boarding/offboarding during peak hours, I've witnessed 1<sup>st</sup> hand the chaos that is the current bike car capacity. Though most bikers are pleasant people (thankfully), the situation of unlocking your bike, digging for your bike, and handling others' [very nice\$\$] bikes can be quite nerve-wrecking for a beginner like me. With the ridership numbers increasing all over, it's bound to get severely worse.

As you may know, LinkedIn Corporation is a proud participant in the Caltrain Go Pass Program. We purchase approximately 3500 stickers annually for all employees in the Bay Area and have so far issued close to 2k 2015 stickers. In my role as a Transportation Coordinator, I am at every New Hire Orientation and heavily promote the use of Caltrain and biking. At this rate, there's likely 1-2 more permanent bikers on Caltrain from our promotion alone. Since I also bike on Caltrain, it's easier to encourage others to do the same.

I'm excited to know that you're recommending a \$3 million investment for bike parking. That will surely help with our Employee Transportation initiatives since we provide shuttles to/from the Caltrain stations in MV and SV, so a "last mile" biking method isn't always necessary. Personally, I prefer biking the rest of the way to work, since I'm only a mile away from the Sunnyvale Station (I know, how did I get so lucky?!).

With my above declaration, I hereby support the transit agency to make an official goal that at least 20% of Caltrain passengers will have access to bike storage/parking. With the residency rate ever increasing in the Bay Area, I challenge a 25% for the 2020 project, but that may be overly ambitious, perhaps not. 😊

As a daily Caltrain Commuter by bike, I am anxious to know the outcome and look forward to the future of Caltrain!

Sincerely,

**Kora Anzellotti**  
Global Transportation Program Coordinator  
Global Workplace Services



m. 530-301-8040

d. 408-604-7297

[kanzellotti@linkedin.com](mailto:kanzellotti@linkedin.com)

[www.linkedin.com/in/kanzellotti](http://www.linkedin.com/in/kanzellotti)

## McKenna, Nancy

---

**From:** Becca del Monte <BDeMonte@projectfrog.com>  
**Sent:** Tuesday, June 30, 2015 2:14 PM  
**To:** Board (@caltrain.com); cacsecretary (@caltrain.com); Caltrain, Bac (@caltrain.com)  
**Cc:** janice@sfbike.org; bikesonboard@sfbike.org  
**Subject:** I Support More Bike Space On Board and More Bike Parking for Caltrain

Hi,

As a bike rider who uses the Caltrain regularly and is considering a job that would involve a daily Caltrain commute, I urge you to pass a design that provides capacity for at least 16 percent of Caltrain passengers and make it a goal to have 20 percent of Caltrain passengers access the system by bike in 2020. Thanks for your recommendation of a \$3 million dollar investment in bike parking, as this would be critical to my commute – please approve this recommendation.

Thanks,

---

Becca del Monte  
Product Design Engineer



Project Frog, Inc.  
501 Second Street, Suite 120  
San Francisco, California 94107  
Mobile: 214.676.3685

**McKenna, Nancy**

---

**From:** restuta8@gmail.com  
**Sent:** Tuesday, June 30, 2015 2:11 PM  
**To:** Board (@caltrain.com); cacsecretary (@caltrain.com); Caltrain, Bac (@caltrain.com)  
**Cc:** janice@sfbike.org; bikesonboard@sfbike.org  
**Subject:** I Support More Bike Space On Board and More Bike Parking for Caltrain

Sent from my iPhone

## McKenna, Nancy

---

**From:** Amanda Fanniff <amanda.fanniff@gmail.com>  
**Sent:** Tuesday, June 30, 2015 2:10 PM  
**To:** Board (@caltrain.com); cacsecretary (@caltrain.com); Caltrain, Bac (@caltrain.com); janice@sfbike.org; bikesonboard@sfbike.org  
**Subject:** Bikes & Caltrain

Dear Caltrain Board,

As a bike/Caltrain commuter, I'd like to thank you for the efforts already undertaken to support bike commuters. I heartily support the recommendation for a \$3 million investment in secure bike parking and also hope that on July 2, the Board votes to increase bike capacity. I live in SF and work in Los Altos; without bike access I would not be able to use Caltrain to get to my office and would have to resort to driving to work. I'm sure there are many like me who would like to continue (or start!) relying upon a more environmentally-friendly commute option.

Additionally, I hope that the Board sets an official goal that at least 20% of Caltrain riders will access the system by bike by 2020. I think it is possible to increase ridership and use of bikes to access Caltrain simultaneously in a way that maximizes the benefits (regarding traffic congestion, environmental impact, etc.).

Thank you for your time and consideration,

Amanda Fanniff

## McKenna, Nancy

---

**From:** jean michel boujon <jmboujon@gmail.com>  
**Sent:** Tuesday, June 30, 2015 2:10 PM  
**To:** Board (@caltrain.com); cacsecretary (@caltrain.com); Caltrain, Bac (@caltrain.com)  
**Cc:** janice@sfbike.org; bikesonboard@sfbike.org  
**Subject:** I Support More Bike Space On Board and More Bike Parking for Caltrain

Dear board member,

it has been a great opportunity for a commuter like me to put my bike on the train.  
I am saving 30 minutes a day by bike/train commuting. Thank you.  
I have been in situations where the train conductor asked me to stay on the platform because of a lack of bike room.

You don't only play a major role in cleaning the Bay Area air by electrifying your trains, you give the opportunity to more people to exercise everyday while they commute to Caltrain and make our cities more sustainable.

Your decision goes beyond Caltrain. It is a wellness decision.

For all this, I support more bike space in board and I hope you will as well.

Best,

Jean-Michel Boujon  
415 235 4039



## McKenna, Nancy

---

**From:** Diklic, Ranka <rdiklic@syska.com>  
**Sent:** Tuesday, June 30, 2015 2:04 PM  
**To:** Board (@caltrain.com); cacsecretary (@caltrain.com); Caltrain, Bac (@caltrain.com)  
**Cc:** janice@sfbike.org; bikesonboard@sfbike.org  
**Subject:** I Support More Bike Space On Board and More Bike Parking for Caltrain

Dear Caltrain,

I work in downtown San Francisco and commute every day from/to San Jose, for years now. Without Caltrain my commute would have been impossible!

You have my full appreciation for allowing space for bikes on the train, since most of the days I bike to Diridon station from my home, than I bike to my office in the City.

Lately I've seen increase in bike riders on the train, and many times people being turn down for lack of space. We would all appreciate to have more bike capacity to allow for at least 16% of passengers. Bikes are taking much less space on the road and not creating pollution. Increasing number of people riding their bikes to Caltrain station is a great goal.

Thank you for investing in secure bike parking and providing more space for bikes on board the trains!

### **Ranka Diklic**

*Senior Plumbing Designer - Associate*

**Syska Hennessy Group, Inc.**



425 California Street.,  
Suite 700  
San Francisco, CA 94104  
Tel: 415.288.9074  
Cell: 408-386-2946  
Email: [rdiklic@syska.com](mailto:rdiklic@syska.com)  
<http://www.syska.com>

 Please consider the environment before printing this e-mail

---

This email and any files transmitted with it are the property of SH Group, Inc. and are intended solely for the use of the individual or entity to which they are addressed. The information contained herein may include trade secrets or privileged or otherwise confidential information and unauthorized review, forwarding, printing, distributing, or using such information is strictly prohibited and may be unlawful. If you received this message in error, or have reason to believe you are not authorized to receive it, please promptly delete this message and notify the sender by e-mail.

---

## McKenna, Nancy

---

**From:** Drew Skau <dwskau@gmail.com>  
**Sent:** Tuesday, June 30, 2015 2:00 PM  
**To:** Board (@caltrain.com); cacsecretary (@caltrain.com); Caltrain, Bac (@caltrain.com)  
**Cc:** janice@sfbike.org; bikesonboard@sfbike.org  
**Subject:** I Support More Bike Space On Board and More Bike Parking for Caltrain

Dear Caltrain,

Bikes and trains are wonderfully complementary forms of transport. Trains are high capacity efficient ways to move long distances, and bicycles provide the freedom and flexibility needed to get to and from a train station. Having infrastructure that supports this complementary relationship is important to maintaining happy Caltrain ridership, helping to reduce carbon footprints, and making it easy to get around the Bay Area. I fear that a failure to adequately support this infrastructure in the upcoming changes would mean a system poorly designed, and incapable of meeting the needs of Bay Area residents. Please do everything you can to increase the number of bicycles allowed on Caltrain cars.

Thanks,  
Drew

## McKenna, Nancy

---

**From:** Venecia Jacobs <Venecia.Jacobs@ucsf.edu>  
**Sent:** Tuesday, June 30, 2015 1:59 PM  
**To:** Board (@caltrain.com); cacsecretary (@caltrain.com); Caltrain, Bac (@caltrain.com)  
**Cc:** janice@sfbike.org; bikesonboard@sfbike.org  
**Subject:** I Support More Bike Space On Board and More Bike Parking for Caltrain

Hi there

I ride most every day from San Bruno to SF. I start by riding my bike from my house to the train, take the train from San Bruno to 4th and King, and then to the VAMC which is on 4150 Clement St.

(and visa versa on my evening) Riding about 18 miles a day.

I love not having to drive a car, and I love the train is so amazing.

I have been bumped a few times, and though I know its for my safety, it still is not easy as then I get to work late.

It would be beneficial to have 1 more bike car!

Thank you,

Venecia Jacobs

## McKenna, Nancy

---

**From:** Aaron Hebert <hebert.aaron@gmail.com>  
**Sent:** Tuesday, June 30, 2015 1:57 PM  
**To:** Board (@caltrain.com); cacsecretary (@caltrain.com); Caltrain, Bac (@caltrain.com)  
**Cc:** janice@sfbike.org; bikesonboard@sfbike.org  
**Subject:** I Support More Bike Space on Caltrain

Dear Board Members,

I am writing to show my support for additional biking capacity on Caltrain.

I have been riding my bike to 22nd Street Caltrain to Mountain View for 5 years. I have seen the 7AM train go from 4-5 regular bicyclists to 20 bicyclists in that time. This is earliest bullet down the Peninsula and it is nearly full every day.

As a project manager and planner for a government agency, I can appreciate the effort it takes to accommodate every user.

I believe firmly you should increase bike capacity on Caltrain, but my challenge to you is to build in flexible designs so that there is a healthy margin of error. What if the SF Bike Coalition's projections are correct? Please ask your staff build flexible interior spaces to accommodate bikes, luggage--whatever is happening on Caltrain 20 years from now.

Respectfully,

Aaron Hebert

## McKenna, Nancy

---

**From:** Robert King <roking@hotwire.com>  
**Sent:** Tuesday, June 30, 2015 1:55 PM  
**To:** Board (@caltrain.com); cacsecretary (@caltrain.com); Caltrain, Bac (@caltrain.com)  
**Cc:** janice@sfbike.org; bikesonboard@sfbike.org  
**Subject:** I Support More Bike Space On Board and More Bike Parking for Caltrain

Hello,

I'm writing today to urge you to pass an updated Caltrain design that provides bike capacity for at least 16 percent of Caltrain passengers. As a long time San Francisco resident, I would also like to let you know that support your goal of having at least 20 percent of Caltrain passengers accessing the system by bike by 2020.

Lately, I want to say thank you for recommending the \$3 million investment in secure bike parking! I strongly encourage the board to approve this recommendation.

Thank you!

Robby

—  
*robby king*  
[\(415\) 812-9899](tel:(415)812-9899)

## McKenna, Nancy

---

**From:** Megan Wachs <megan.wachs@gmail.com>  
**Sent:** Tuesday, June 30, 2015 1:50 PM  
**To:** Board (@caltrain.com); cacsecretary (@caltrain.com); Caltrain, Bac (@caltrain.com)  
**Cc:** janice@sfbike.org; bikesonboard@sfbike.org  
**Subject:** I Support More Bike Space On Board and More Bike Parking for Caltrain

Hello,

I am a regular Caltrain rider and usually bring my bike on the train. Additionally, my significant other lives and works on the Peninsula and uses bike+Caltrain daily to get to/from SF. Without the bike+train combo, we have to deal with parking a car in the city (always a source of stress). If I change jobs, the ability to get to the Peninsula with bike+train is a big consideration in my job search. So it is very important to both of us that bike capacity on the new trains is as high as possible. 16% of passengers or higher seems like a good start, it is very frustrating to work out the train schedule then get bumped.

I have had many bikes stolen over the years, and one was at a Caltrain station (in Palo Alto). Since then I never leave my bike locked at a station, and the secure bike parking like the one at 4th & King is essential. Thank you for recommending the investment in secure bike parking, I hope it is approved.

Thanks for your consideration,  
Megan Wachs  
San Francisco Resident

## McKenna, Nancy

---

**From:** Bart Renner <bartrenner@gmail.com>  
**Sent:** Tuesday, June 30, 2015 1:46 PM  
**To:** Board (@caltrain.com); cacsecretary (@caltrain.com); Caltrain, Bac (@caltrain.com)  
**Cc:** janice@sfbike.org; bikesonboard@sfbike.org  
**Subject:** I Support More Bike Space On Board and More Bike Parking for Caltrain

To whom it may concern:

We desperately need more bike cars for peak travel times. Also, we routinely experience non-bike travelers crammed into the bike cars which creates traffic jams, slower station deboarding and onboarding, and general frustration.

Please help us out!!!

Sincerely,

Bart Renner (bike commuter from Mountain View to SF)

## McKenna, Nancy

---

**From:** Mike Francis <mfrancis@sunedison.com>  
**Sent:** Tuesday, June 30, 2015 1:44 PM  
**To:** Board (@caltrain.com); cacsecretary (@caltrain.com); Caltrain, Bac (@caltrain.com)  
**Cc:** janice@sfbike.org; bikesonboard@sfbike.org  
**Subject:** I Support More Bike Space On Board and More Bike Parking for Caltrain

Dear Caltrain Board,

As you all consider the future of Caltrain, I hope you will strongly support more bike space on Caltrain and at Caltrain Stations!

Best,  
Mike

--

**Mike Francis**  
*Portfolio Manager*

Mobile: 650.440.0199  
Email: [mfrancis@sunedison.com](mailto:mfrancis@sunedison.com)

**SunEdison**  
44 Montgomery Street, Suite 2200  
San Francisco, CA 94104  
[www.sunedison.com](http://www.sunedison.com)

---

Confidentiality Statement of SunEdison and its subsidiaries: The contents of this message, together with any attachments, are intended only for the use of the individual or entity to which they are addressed and may contain information that is legally privileged and confidential. If you are not the intended recipient, you are hereby notified that any dissemination, distribution, or copying of this message, or any attachment, is strictly prohibited. If you have received this message in error, please notify the original sender immediately by telephone or by return E-mail and delete this message, along with any attachments, from your computer.  
No Contract: Regardless of content, this email shall not operate to bind SunEdison or its subsidiaries to any purchase order or contract unless pursuant to a written agreement signed by SunEdison or its subsidiaries expressly permitting the use of email for such purpose.



## McKenna, Nancy

---

**From:** Jim Kubicek <jkubicek@twitter.com>  
**Sent:** Tuesday, June 30, 2015 1:44 PM  
**To:** Board (@caltrain.com); cacsecretary (@caltrain.com); Caltrain, Bac (@caltrain.com)  
**Cc:** janice@sfbike.org; bikesonboard@sfbike.org  
**Subject:** I Support More Bike Space On Board and More Bike Parking for Caltrain

Dear Caltrain,

As a regular bike passenger on Caltrain during the morning and evening rush hours, I strongly support adding additional bike capacity to our trains. As I'm sure you know, our rush hour trains are filled beyond capacity.

I would like to support the following:

- \* Provide capacity for at least 16% of Caltrain passengers
- \* Make it an official goal that at least 20% of Caltrain passengers will access the system by bike by 2020

Also, thanks to the staff for recommending a \$3m investment in secure bike parking.

Cheers and happy Caltraining!

—

Jim Kubicek  
jimk@twitter.com

## McKenna, Nancy

---

**From:** Mimi Torres <mimi.e.torres@gmail.com>  
**Sent:** Tuesday, June 30, 2015 12:41 PM  
**To:** Board (@caltrain.com); cacsecretary (@caltrain.com); Caltrain, Bac (@caltrain.com)  
**Cc:** janice@sfbike.org; bikesonboard@sfbike.org  
**Subject:** I Support More Bike Space On Board and More Bike Parking for Caltrain

Dear Caltrain Board,

I am very grateful for Caltrain's goal of reaching 20% of passenger trips by bike by 2020 and also to the Caltrain staff for recommending \$3 million investment in secure bike parking. I encourage the Board to approve this recommendation. I also urge you to pass a design that provides bike capacity for at least 16 percent of Caltrain passengers. I have lived in the Bay Area for 6.5 years and have seen biking as a method of transportation grow more and more popular with each year. This is only likely to continue so it makes sense to increase bike space now instead of later.

Thank You,

Mimi Torres  
Berkeley, CA

•

--

Mimi Torres  
(928) 225-1071  
[mimi.e.torres@gmail.com](mailto:mimi.e.torres@gmail.com)

## McKenna, Nancy

---

**From:** Thomas E. Jerde <thomasjerde@gmail.com>  
**Sent:** Tuesday, June 30, 2015 12:16 PM  
**To:** Board (@caltrain.com); cacsecretary (@caltrain.com); Caltrain, Bac (@caltrain.com)  
**Subject:** I urge you to support more and smarter bike capacity for Caltrain's future designs

Dear members of the board,

It's been so gratifying to see real evidence for your support of daily commuting cyclists' interests in their ever-increasing ridership of Caltrain. Thank you very much for recognizing this growing segment of riders and how integral bike capacity and bike parking are to their transit solutions.

For me personally, my bike is truly crucial to the first and last miles of my daily commute. In SF, the MUNI service is simply too slow and unreliable (by bike it reliably takes me 10 minutes to reach 4th & King, whereas to make sure not to miss my train via MUNI it seems I have to budget about 45 minutes). And in Palo Alto, there's no good service to speak of to get to my office, but on a bike it's a breeze. If I couldn't depend on getting my bike onto the train, I would simply have to divide my days between driving and telecommuting.

I urge you today to not only continue your present support but to plan ahead for the future, particularly with the upcoming opportunity to reshape the design of the cars and system. Bike ridership overall will continue to grow fast. As an increasing proportion of Caltrain riders are cyclists, it seems the three critical necessities are:

- boost the percentage of passengers afforded bike capacity on the trains
- expand and improve secure bike parking at stations
- design platforms to allow all passengers, including those with disabilities and those with bikes, can quickly and safely board and detrain together.

And a "nice to have" as far as I'm concerned:

- on those occasions when there are Caltrain service interruptions (which will hopefully become rarer), **improved notifications** about remaining bike capacity on delayed trains would really help those of us who *could* leave our bikes behind in these emergencies if we only had a few minutes warning to find a secure spot for them. That would sure beat the additional frustration of being bumped from already-delayed trains.

Thanks very much for your consideration. I'm very much looking forward to seeing the results of your upcoming meeting.

Sincerely,  
Thomas Jerde  
cycling Caltrain rider since 2004

**McKenna, Nancy**

---

**From:** Ben Hess <benahess@gmail.com>  
**Sent:** Tuesday, June 30, 2015 12:11 PM  
**To:** Board (@caltrain.com); cacsecretary (@caltrain.com); Caltrain, Bac (@caltrain.com)  
**Cc:** janice@sfbike.org; bikesonboard@sfbike.org  
**Subject:** I Support More Bike Space On Board and More Bike Parking for Caltrain

I don't always take my bike on Caltrain, but when I do, I'd like to have ample space and parking.

- Ben, Half Moon Bay

## McKenna, Nancy

---

**From:** Rachel B. Baker <rbbaker@stanford.edu>  
**Sent:** Tuesday, June 30, 2015 11:55 AM  
**To:** Board (@caltrain.com); cacsecretary (@caltrain.com); Caltrain, Bac (@caltrain.com)  
**Cc:** janice@sfbike.org; bikesonboard@sfbike.org  
**Subject:** I Support More Bike Space On Board and More Bike Parking for Caltrain

Thanks for all you have done for bike commuters like me (22nd St to Palo Alto). Please continue to make this a priority (by having enough bike space on cars)-- such a wonderful way to get around the Bay Area and the best way to commute!

Thank you,  
Rachel Baker, PhD  
Stanford Graduate School of Education

## McKenna, Nancy

---

**From:** Clayton Hurd <churd@stanford.edu>  
**Sent:** Tuesday, June 30, 2015 11:36 AM  
**To:** Board (@caltrain.com); cacsecretary (@caltrain.com); Caltrain, Bac (@caltrain.com)  
**Cc:** janice@sfbike.org; bikesonboard@sfbike.org  
**Subject:** I Support More Bike Space On Board and More Bike Parking for Caltrain

Dear Caltrain Board:

I wish to thank the Caltrain staff, first of all, for recommending a significant \$3 million investment in secure bike parking. I commute with my bike every day, and my life would be made a great deal easier if there were opportunities to securely park my bike at various stations; particularly Palo Alto and Redwood City. I highly encourage the Board to approve the recommendation for this investment. I also support the proposal to pass a design that provides bike capacity for at least 16 percent of Caltrain passengers.

Thanks for your time and attention,  
Clayton

---

Clayton A. Hurd, Ph.D.  
Senior Program Director of Public Service Research & Graduate Engaged Scholarship  
Haas Center for Public Service  
Stanford University  
562 Salvatierra Walk  
Stanford, CA 94305-8620

## McKenna, Nancy

---

**From:** Lídia Paes Leme <lidia.paesleme@gmail.com>  
**Sent:** Tuesday, June 30, 2015 11:36 AM  
**To:** Board (@caltrain.com); cacsecretary (@caltrain.com); Caltrain, Bac (@caltrain.com)  
**Cc:** janice@sfbike.org; bikesonboard@sfbike.org  
**Subject:** I Support More Bike Space On Board and More Bike Parking for Caltrain

Good morning,

I ride caltrain and usually bring my bike with me. I realize more and more people are riding bikes and combining that transportation with caltrain rides. Therefore, I urge the Caltrain Board to pass a design that provides bike capacity for at least 16 percent of Caltrain passengers; and I support the transit agency making it an official goal that at least 20 percent of Caltrain passengers will access the system by bike by 2020; and I thank Caltrain staff for recommending a significant \$3 million investment in secure bike parking, and I encourage the Board to approve this recommendation!

Thank you,

Lidia Paes Leme Arantes  
650-889-6038  
[lidia.paesleme@gmail.com](mailto:lidia.paesleme@gmail.com)

## McKenna, Nancy

---

**From:** Hilary Douglas <hilaryd@stanford.edu>  
**Sent:** Tuesday, June 30, 2015 11:17 AM  
**To:** Board (@caltrain.com); cacsecretary (@caltrain.com); Caltrain, Bac (@caltrain.com)  
**Cc:** janice@sfbike.org; bikesonboard@sfbike.org  
**Subject:** I Support More Bike Space On Board and More Bike Parking for Caltrain

Dear Caltrain,

I ride my bike four miles to the 4<sup>th</sup> and King Caltrain Station, take the train to Palo Alto, then ride my bike a mile and a half to my office. All in all it takes me about 90 minutes each way. My bike and Caltrain are essential to my commute and I rather enjoy both experiences. I love getting a bit of exercise in followed by some time to get my reading done. I've been bumped from crowded trains and have learned to skip specific trains because I know the capacity for my bike and I will be limited. (I NEVER ride bombardier trains because there is never enough space.)

In recent days, even as I attempt to travel semi-off peak, the bike car is getting more and more crowded. As such, trains are running a few minutes late to accommodate bikes getting on and off and conductors are expressing frustration towards cyclists. Last night AND this morning conductors seemed at their wits end though no one was doing anything wrong. The majority of bikers have great train etiquette, but there just isn't enough room for all of us to maneuver let alone stack our bikes. Even as we attempt to follow the rules - going all the way to the back to get everyone on before racking our bikes, placing only four bikes to a rack, tagging our stops - we are getting reprimanded for delayed trains. This morning on SB 220 there were five or six bikes to most racks. It made it very hard to navigate as we tried to get off the train. The alternative would've been 10 - 12 people getting bumped from the train and unable to make it to work on time. As it was, we were all going to be seven or eight minutes late. The conductor continued to point out that it was the bikers fault and that we needed to move faster, but there was literally no way to do that.

Increased bike capacity is good for riders and conductors alike. More and more people are biking which is great for the individual, as well as the community. It is something we should all be encouraging and supporting. While bike storage and bike shares help, there are still the majority of us that need our bikes on both ends of our commute. I am extremely grateful that I am able to bring my bike onboard, but I am worried about the next few years. As the San Francisco and Bay Area population grows, so will the number of Caltrain riders and so will the number of bikers. There is just barely enough room for all of us now. Please consider increasing bike capacity to aid everyone in a timely, efficient commute.

Thank you for your consideration.  
Hilary Douglas  
San Francisco, CA



## McKenna, Nancy

---

**From:** Sarah Truebe <struebe@stanford.edu>  
**Sent:** Tuesday, June 30, 2015 11:04 AM  
**To:** Board (@caltrain.com); cacsecretary (@caltrain.com); Caltrain, Bac (@caltrain.com)  
**Cc:** janice@sfbike.org; bikesonboard@sfbike.org  
**Subject:** I Support More Bike Space On Board and More Bike Parking for Caltrain

Hello,

Please vote for bike-friendly options for Caltrain! I walk to and from the train station because every morning I see so many people left behind on bike - I don't even try to bike because there isn't enough bike capacity on the train or in parking areas at the station. Please vote for a bike-friendly redesign!

Thank you,  
Sarah Truebe

—  
[Sarah Truebe](#)

Director of Community-Engaged Learning, Environmental Sustainability  
Stanford University | Sweet Hall 126C | 650-497-6537 | [struebe@stanford.edu](mailto:struebe@stanford.edu)

## McKenna, Nancy

---

**From:** Nathaniel Evin Berger <neberger@stanford.edu>  
**Sent:** Tuesday, June 30, 2015 10:57 AM  
**To:** Board (@caltrain.com); cacsecretary (@caltrain.com); Caltrain, Bac (@caltrain.com)  
**Cc:** janice@sfbike.org; bikesonboard@sfbike.org  
**Subject:** I Support More Bike Space On Board and More Bike Parking for Caltrain

Hello,

As a dedicated Caltrain customer and someone who relies on commuting with their bike, increased Bike Capacity onboard Caltrain is vitally important!

I urge the Caltrain Board to pass a Design that provides bike capacity for at least 16 percent of Caltrain passengers. I support the transit agency making it an official goal that at least 20 percent of Caltrain passengers will access the system by bike by 2020.

And finally, I thank Caltrain staff for recommending a significant \$3 million investment in secure bike parking and encourage the Board to approve this recommendation.

With respect,

Nathaniel

Nathaniel E. Berger, M.S.  
Program Manager, Community Engaged Learning and Research  
Haas Center for Public Service  
Stanford University  
Email: [neberger@stanford.edu](mailto:neberger@stanford.edu)  
Phone: 650.723.0066

## McKenna, Nancy

---

**From:** Valerie Chow <valerieychow@gmail.com>  
**Sent:** Tuesday, June 30, 2015 10:46 AM  
**To:** Board (@caltrain.com); cacsecretary (@caltrain.com); Caltrain, Bac (@caltrain.com)  
**Cc:** janice@sfbike.org; bikesonboard@sfbike.org  
**Subject:** I Support More Bike Space On Board and More Bike Parking for Caltrain

Dear Caltrain Board,

I am an avid rider of Caltrain, and use it as my primary mode of commuter transportation. I also bring my bike on the train each weekday. I am supportive of the San Francisco Bicycle Coalition's demands with respect to the new train designs, as I believe that there is inadequate bike space on the current trains.

In line with the SF Bicycle Coalition's demands, I believe that the new trains should provide bike capacity for at least 16 percent of Caltrain passengers. I am also in support of the transit agency making it an official goal that at least 20 percent of Caltrain passengers will access the system by bike by 2020.

Thank you very much for your time and consideration.

Regards,  
Valerie Chow

## McKenna, Nancy

---

**From:** LC Jones <lcjones37@earthlink.net>  
**Sent:** Tuesday, June 30, 2015 10:17 AM  
**To:** Board (@caltrain.com); cacsecretary (@caltrain.com); Caltrain, Bac (@caltrain.com)  
**Cc:** janice@sfbike.org; bikesonboard@sfbike.org  
**Subject:** I Support More Bike Space On Board and More Bike Parking for Caltrain

Hello!

I'm a SF Bicycle Coalition member, and use Caltrain with my bicycle. In my experience, Caltrain definitely needs more bike capacity, and more secure bike parking. For those of us without motor vehicles, it really makes a huge difference in our ability to travel in the Bay Area.

Thanks for your consideration.

Sincerely,  
Leslie Jones

## McKenna, Nancy

---

**From:** Amira Atallah <amiraathome@yahoo.com>  
**Sent:** Monday, June 29, 2015 2:20 PM  
**To:** Board (@caltrain.com); cacsecretary (@caltrain.com); Caltrain, Bac (@caltrain.com)  
**Cc:** janice@sfbike.org; bikesonboard@sfbike.org  
**Subject:** I Support More Bike Space On Board and More Bike Parking for Caltrain

Dear Caltrain Board members,

I am writing to thank you for the efforts you have made so far to provide bike access on Caltrain and to encourage you to do even more in your upcoming planning.

Caltrain is a system that will work for more and more people if they have an easy way to connect the station to their home or to their destination. As more people become comfortable using a bike to close this gap, and as bike lanes are added in more cities, more space for bikes to travel and also to safely park at stations will be needed.

It takes much less space to provide bike parking than car parking, and so additional secure bike parking is a very efficient way to increase ridership.

The future Bay Area will rely more and more on bikes as alternatives to cars as our population rises. Now is the time to plan for this future.

Thank you,

Amira Atallah

## McKenna, Nancy

---

**From:** Brett Malak <bmalak@teslamotors.com>  
**Sent:** Monday, June 29, 2015 11:04 AM  
**To:** Board (@caltrain.com)  
**Cc:** Caltrain, Bac (@caltrain.com); cacsecretary (@caltrain.com); Murphy, Seamus; Nabong, Sarah; bikesonboard@sfbike.org  
**Subject:** Caltrain bike capacity planning

Hello,

I'm writing to express appreciation for existing Caltrain bike capacity, and to encourage planning for increased capacity. As a conscious commuter, I continually look for ways to reduce my impact on the world around me, and using a combination of pedal and train power is among the best ways I can do that. Getting bumped from the train because of a bicycle is a frustrating experience, and not consistent with the way we should be thinking about transit in the bay area.

I want to ensure that bringing bicycles on the train remains a viable option for commuters, so in your upcoming meeting on July 2, please commit to increasing Caltrain bike capacity so that 20% of passengers could bring bikes onboard by 2020.

Thanks and kindest regards,  
Joseph Malak  
San Jose, California

## McKenna, Nancy

---

**From:** Zoe Hoster <zoe.hoster@gmail.com>  
**Sent:** Monday, June 29, 2015 10:06 AM  
**To:** Board (@caltrain.com); cacsecretary (@caltrain.com); Caltrain, Bac (@caltrain.com)  
**Cc:** Janice Li; bikesonboard@sfbike.org  
**Subject:** I Support More Bike Space On Board and More Bike Parking for Caltrain

Dear Caltrain Board,

I am writing to express my support for increased bike space in the new train cars and increased bike parking. Bikes are an essential component of almost every Caltrain trip I make, whether commuting or on the weekend. My destinations are a convenient bike ride away from the station, but a bit too far to walk.

With more and more people bringing bikes on the train, it will become unreliable whether there will be space for you or not. Without reliability, people will choose to drive instead. Without secure bike parking at the stations, it's too risky to leave your bike parked at the station.

Thank you

Zoe Hoster

--

Zoë Hoster  
+1 415 269 7621

## McKenna, Nancy

---

**From:** Trevor Tubelle <ttubelle@stanford.edu>  
**Sent:** Monday, June 29, 2015 9:49 AM  
**To:** Board (@caltrain.com)  
**Cc:** bikesonboard@sfbike.org; Nabong, Sarah; Murphy, Seamus; cacsecretary (@caltrain.com); Caltrain, Bac (@caltrain.com)  
**Subject:** Increase bike capacity

Hello,

I am writing to strongly encourage you to increase bike capacity on future electrified trains (20% of capacity or more) in excess of the inadequate amount recommended by your staff. I live in SF and commute down to Stanford to teach via Caltrain and have experienced being "bumped" numerous times (and therefore missed a number of important meetings). If I can't reliably commute via bike and Caltrain without worrying about being bumped, I will have to start driving my car instead (which is a last resort for me).

I assume the whole point of electrification is to make Caltrain a "greener" and more sustainable form of transportation, so it would seem obvious that encouraging and supporting people who bike (just about the cleanest/greenest way to commute aside from walking) would be an obvious priority for Caltrain. Please work towards a more sustainable future for public transportation by increasing bike capacity--*if you build it, they will come!*

Thank you,

Trevor Tubelle

San Francisco, CA

### **Trevor Tubelle**

Lecturer, Honors in the Arts  
Stanford Arts Institute  
Littlefield Center  
365 Lasuen Street, 2nd Floor  
Room 210  
Stanford University  
Stanford, CA 94305

artsinstitute.stanford.edu  
tubelle.com



## McKenna, Nancy

---

**From:** Andrew Titus <atitus@gmail.com>  
**Sent:** Monday, June 29, 2015 8:25 AM  
**To:** Board (@caltrain.com)  
**Cc:** Nabong, Sarah; Murphy, Seamus; cacsecretary (@caltrain.com); Caltrain, Bac (@caltrain.com); bikesonboard@sfbike.org  
**Subject:** Bike capacity - electrification

Caltrain Board of Directors

I have been a frequent rider of Caltrain since January of 2011. I have always brought a bike with me onboard, and for the vast majority of this time have been a monthly pass holder. I ride the train from San Francisco to Palo Alto, with various combinations of 4th&king, 22nd street, University Avenue and California Avenue. When I first moved here I was incredibly impressed with how progressive it was for a major transit system to have accommodation for people who want to bring their bikes. I don't live close to the Caltrain stations in the city, or work close to the stations in Palo Alto, so bringing my bike onboard allows me to make my commute time manageable when compared to taking public transit on either end. It also allows me to get some exercise during my commute, and to avoid driving.

I'm very disappointed to hear that Caltrain is not planning on increasing bike capacity for its next fleet. I have seen the bike cars getting more and more full every year, with ever increasing numbers of bike passengers being left behind on the platform. It seems seems short sighted to plan for today's ridership levels. I would strongly encourage you to reconsider the 11% bike allotment, and would ask that you increase it to 20% as proposed by the San Francisco Bike Coalition. The freeways are only going to get busier as more people move to the bay area, and we should be doing everything that we can to give people transportation options which are environmentally friendly and healthy!

Thank you for your time, and I hope that during your July 2nd meeting you will vote against your staff recommendation of only 11% bike capacity. Please help to increase the bike capacity for future Caltrain riders, including myself.

Andrew Titus  
San Francisco

## McKenna, Nancy

---

**From:** Kevin Jackson <kjbiker@netzero.net>  
**Sent:** Sunday, June 28, 2015 9:12 PM  
**To:** cacsecretary (@caltrain.com); Caltrain, Bac (@caltrain.com);  
adina.levin@friendsofcaltrain.com  
**Subject:** Provide adequate bike capacity!

Dear Caltrain board:

I am appalled to hear that the staff recommendation for bike space on electrified trains is no greater than the current (inadequate) level. Bike/train commuting is probably the most popular car-free option in the corridor for trips of any distance, and this environmentally responsible mode has the potential for major growth as long as it is shown to be reliable by providing sufficient capacity.

Accommodating bikes on board results in significant benefits far beyond increasing ridership. Many potential users currently drive to the station, adding to traffic congestion during peak travel times and consuming substantial resources dedicated to parking. In my city, and no doubt many others, there is also a great deal of ill will generated among neighboring residents due to spillover parking. And even though the distance may be relatively short, the two cold starts of each car driven to and from the station contribute disproportionately to air pollution, energy consumption, and greenhouse gas emissions.

All of this adds up to a pretty compelling case for prioritizing additional bike space on the new trains, beyond what may be suggested by some spreadsheet calculation that fails to take into account many very important considerations. Why is it that whenever there is a shortage of automobile capacity the automatic response is to do everything possible to correct it, yet similar concerns for bicyclists are routinely shrugged off as non-essential? Just how bad do things have to get before we start taking seriously the need to give many more people some real choices in transportation?

You have an excellent opportunity to take a big step forward by rejecting the staff recommendation and insisting on bike capacity of at least twenty percent (and to plan for further increases as conditions warrant). Please demonstrate your environmental leadership by taking this action in order to help insure the long-term sustainability of our beautiful yet increasingly fragile Bay Area.

Thank you for your consideration.

Kevin Jackson  
Sunnyvale

---

Old School Yearbook Pics

View Class Yearbooks Online Free. Search by School & Year. Look Now!

<http://thirdpartyoffers.netzero.net/TGL3231/5590c5a465ba745a40869st03duc>

## McKenna, Nancy

---

**From:** Jim Hartman <bucketbiochemist@yahoo.com>  
**Sent:** Sunday, June 28, 2015 4:52 PM  
**To:** Board (@caltrain.com); cacsecretary (@caltrain.com); Caltrain, Bac (@caltrain.com)  
**Cc:** janice@sfbike.org; bikesonboard@sfbike.org  
**Subject:** I Support More Bike Space On Board and More Bike Parking for Caltrain

Dear Directors and Managers of Caltrain,

I have been a Caltrain rider since 1999, commuting weekdays between 4th & King Station and South San Francisco. Throughout that time, I have made continuous use of either Bikes on Board, secure bike lockers, or the SF Bike Station parking. Having the ability to couple bike and train transport greatly facilitates my commute, as I only need to use one form of mass transit. The ability to carry my bike on board has been most helpful, as I can use it for transport on both ends. Eliminating the need to using two forms of mass transit is a significant draw for me as I don't need to build extra buffer time for transfers, and I think there are many other cyclists sharing that sentiment. I have been fortunate in having sufficient bike capacity at the moment for my stations/times, however I have observed the high level of congestion for people traveling in other directions/times. Please do make every effort to support increased bike capacity in your next generation of trains. The ability to travel with a bike greatly increases flexibility on both ends of a journey, and I sincerely believe it will be of increasing importance for riders going forward. Now is the time to build this into the train design, not later as a retrofit.

Finally, please support Caltrain staff's recommendation for a \$3 million investment bike parking. I am currently using the SF facility to park my cargo bike on most days, as I take my 7 year old to school on the back of this larger bicycle that does not fit on the train. This allows my family to be car-less and for me to continue to use Caltrain for my daily commute. The staff at the SF station are excellent, however they are exceeding their capacity and parking more bikes than ever. Please do support these important investments in bike parking infrastructure.

Please contact me if you need any additional information, and thank you for your time.

Sincerely,

Jim

Jim Hartman  
bucketbiochemist@yahoo.com

## McKenna, Nancy

---

**From:** pierre willard <pierre@willard.com>  
**Sent:** Sunday, June 28, 2015 1:48 PM  
**To:** Board (@caltrain.com)  
**Cc:** bikesonboard@sfbike.org; Nabong, Sarah; Murphy, Seamus; cacsecretary (@caltrain.com); Caltrain, Bac (@caltrain.com)  
**Subject:** Bike space on electrified trains

Hello Caltrain board members,

Just a few words to let you know that today, **80 bike spaces on trains are already not enough**. Especially on Mondays, I witness people with bike getting bumped because the cars are getting full a few stations before reaching San Francisco station. On the way back, it's a similar story: the train leaving SF completely packed, with some bikers left behind.

**Please recommend at least 100 or 120 bikes capacity on ALL the new electrified trains.**

Regards

Pierre Willard (Palo Alto)

## McKenna, Nancy

---

**From:** Matthew Gaul <mnngaul@gmail.com>  
**Sent:** Sunday, June 28, 2015 9:58 AM  
**To:** Board (@caltrain.com); cacsecretary (@caltrain.com); Caltrain, Bac (@caltrain.com)  
**Cc:** bikesonboard@sfbike.org; Janice Li  
**Subject:** I Support More Bike Space On Board and More Bike Parking for Caltrain

Dear Caltrain,

I sincerely appreciate the level of service, both in quality and consistency that you provide. I could take BART to work from where I live, but your service is quicker, cleaner, cheaper, and all around much more enjoyable. Given the distance of my house from where I board and from where I get off to my office, I really need to use my bicycle every day. Other options to get to and from the stations are unreliable, time consuming, and frankly, expensive. My bicycle gives me a unparalleled level of mobility while helping me stay healthy every day.

I urge you to do everything you can to expand the availability of bike space on board to meet the needs of current ridership levels and the needs of future ridership. When riders who have come to expect and depend on Caltrain's level of quality and timliness are bumped from trains they are made to be late to work or late to home. Either way, they let down those who they wish to spend time with and who depend on them. Please help us all have a better day and get to where we want to be most.

Sincerely,  
Matthew Gaul

## McKenna, Nancy

---

**From:** Samuel Hamner <sam.hamner@gmail.com>  
**Sent:** Saturday, June 27, 2015 12:39 PM  
**To:** Board (@caltrain.com); cacsecretary (@caltrain.com); Caltrain, Bac (@caltrain.com)  
**Cc:** janice@sfbike.org; BIKES ONboard  
**Subject:** I Support More Bike Space On Board and More Bike Parking for Caltrain

Dear Caltrain Board,

I am writing as a Caltrain commuter to voice my support of the SF Bike Coalition recommendations for bike capacity and access on the new electrified cars for Caltrain, including:

- Set a transit agency goal that a minimum of 20% of passengers will access Caltrain by bike by 2020;
- Provide bike capacity for at least 16% of Caltrain passengers; and
- Ensure the most accessible platform and car design as possible for all passengers, including seniors, children, people with disabilities and people bringing bicycles onboard.

Bikes + Caltrain just make so much sense for efficient commuting between SF and San Jose. Please include capacity and infrastructure to make biking to and from Caltrain accessible.

Best,

Samuel Hamner

<https://www.linkedin.com/in/samner>

## McKenna, Nancy

---

**From:** Chetan <mcheta@gmail.com>  
**Sent:** Saturday, June 27, 2015 5:56 AM  
**To:** Board (@caltrain.com)  
**Cc:** bikesonboard@sfbike.org; Nabong, Sarah; Murphy, Seamus; cacsecretary (@caltrain.com); Caltrain, Bac (@caltrain.com)  
**Subject:** Please increase bicycle capacity

Hello Caltrain Board members,

I am a resident of San Francisco and work in Mountain View. My residence and workplace are not close to the train stations. Ability to bring bikes on board the train is the only way I can do this commute.

I am very dissatisfied to learn that staff is recommending the same bike capacity on electrified service.

I keep getting bumped on the caltrain because the bike cars get full very often. Biking is on a rise and solves the last mile problem on both ends for me - to/from station and residence/work. More and more people are biking nowadays and keeping the same capacity of bike cars means you are actually worsening the problem of bikers getting bumped in the future.

Please increase the bike capacity to allow 20% of passengers to bring bikes aboard.

Thank you,

Chetan (San Francisco)

## McKenna, Nancy

---

**From:** Elliot Schwartz <elliott.schwartz@gmail.com>  
**Sent:** Saturday, June 27, 2015 12:41 AM  
**To:** Board (@caltrain.com)  
**Cc:** Bikes on Board; Nabong, Sarah; Murphy, Seamus; cacsecretary (@caltrain.com); Caltrain, Bac (@caltrain.com)  
**Subject:** Increase bicycle capacity to 20% in new trains

Caltrain Board --

When I take Caltrain I often bring my bike onboard - it's the fastest and most flexible way to get to the many destinations that are a few miles away from a station. I was dismayed to find out that Caltrain is not yet recommending any increase in bike space on trains. Both bicycling and transit use is growing, so we need to make sure they grow together. Bringing a bike on board is the best or only solution for many train riders - it's too complicated, expensive, and insecure to keep a bike at both ends - transit connections are unreliable and infrequent service means a missed connection is very time consuming - driving is wasteful & parking near train stations can never serve more than a handful of drivers. I am asking that at the July 2 meeting you increase bike capacity to allow at least 16% and preferably 20% of passengers to bring bikes on board the new trains. Only then will Caltrain truly be a solution for those who live & work beyond walking distance from stations.

Elliot Schwartz  
San Francisco, CA



## McKenna, Nancy

---

**From:** Michael Scheper <ms@michaelscheper.com>  
**Sent:** Friday, June 26, 2015 6:48 PM  
**To:** Board (@caltrain.com); cacsecretary (@caltrain.com); Caltrain, Bac (@caltrain.com)  
**Subject:** I Support More Bike Space On Board and More Bike Parking for Caltrain

Hello,

I count on bicycle access in order to use Caltrain. It runs much too infrequently to be able to rely on public transport connections. Please keep Caltrain as bike-friendly as possible. Thank you.

--

ms@michaelscheper.com

Sent from my Android using K-9 mail. Please excuse any brevity or Swype-obfuscation. For more information, refer to <http://xkcd.com/1427/>

## McKenna, Nancy

---

**From:** Barry Marchessault <barry3dat@yahoo.com>  
**Sent:** Friday, June 26, 2015 3:46 PM  
**To:** Board (@caltrain.com)  
**Cc:** bikesonboard@sfbike.org; Nabong, Sarah; Murphy, Seamus; cacsecretary (@caltrain.com); Caltrain, Bac (@caltrain.com)  
**Subject:** Increase Bike Capacity

I purchase a monthly transit pass and I am a cyclist.

Primarily I commute to work from San Bruno to Santa Clara, removing one car and a bad driver off our already congested highways, not to mention CO2 from the atmosphere!

I am disheartened to learn that a rumored increase in bike capacity (coupled with the used car purchase) may not come to pass and that CalTrain Staff is recommending no increase for bike capacity upon electrification (5+ years out) than what is currently available, which I believe is already inadequate.

As heartened as I am by the constantly increasing number of cyclists on trains, I don't even try to get into the city during "civilized" dinner hours for fear of getting bumped, and have organized my schedule to avoid this problem much to the expense of an already struggling social life! On certain trains I have no expectation of sitting anywhere near my bike, which can cause anxiety. Part of me wants to suggest to those intolerant of cyclist's desire to sit near their bikes, that they put their backpacks handbags and belongings on wheels and sit two cars away and let me know how comfortable they are with that reality?

I implore the Caltrain Board to reconsider the staff's recommendation and increase bike capacity as part of the electric conversion plan as well as to continue to increase bike capacity to better meet current capacity as well as likely future growth.

Yours,

Barry Marchessault  
San Bruno, CA

## McKenna, Nancy

---

**From:** Christine Ryan <cbkryan@me.com>  
**Sent:** Friday, June 26, 2015 3:22 PM  
**To:** Board (@caltrain.com)  
**Cc:** bikesonboard@sfbike.org; Nabong, Sarah; Murphy, Seamus; cacsecretary (@caltrain.com); Caltrain, Bac (@caltrain.com)  
**Subject:** please, more space for bikes on trains!

It's incredibly discouraging that this point still needs to be argued, but here goes:

I live in San Francisco and work in Menlo Park—NOT in the tech industry. Back in 2009, when I first started working at this site, I drove to work every day. Even then, the commute was tedious and expensive and time-consuming. But because I tended to work late (too late to take the last baby bullets and express trains), I felt I had to drive. Also, from my home in Bernal Heights, it was cumbersome to get to the nearest Caltrain station: I'd either have to take a (slow) bus downtown, to Fourth and King, or take BART to Millbrae and transfer there to the train. Not impossible, but enough of a hassle that driving seemed preferable.

Then I got a bike.

Now, I ride to the 22nd Street station, catch the 9:02, and am in Menlo Park by 9:35. Heading home, I have to go to the Palo Alto station instead of Menlo Park, to (usually) avoid being bumped, but still, having a bike makes it possible for me to take the train to work every day, and leave my car at home. (It's the ONLY reason I've been able to do so.) In this time, I've watched the traffic on the Peninsula worsen exponentially. (Our offices are on Willow Road, and the backup of cars heading east over the Dumbarton in the evening is becoming a real traffic hazard at the 101 crossing.)

Over the past three years, though, the bike cars have been getting more and more crowded. Caltrain did agree to put three of the new Bombardier cars in each train set (when they're delivered), which I appreciate, but that only keeps bike capacity at status quo. It seems insane not to increase the amount of bike space available on the trains in the future, especially given San Francisco's intentions to increase bike ridership to 20% in the city by the year 2020. Not all of us commuting down the Peninsula can afford to take Uber to the train station, or work at companies that provide corporate shuttles.

Please, in the name of reducing pollution, reducing traffic, and helping the remaining members of SF's middle class get to their jobs down on the Peninsula, consider increasing bike capacity on the electrified trains beyond what we have today.

Thank you,

Christine Ryan  
San Francisco

## McKenna, Nancy

---

**From:** Matt Eggers <matthewreggers@gmail.com>  
**Sent:** Friday, June 26, 2015 2:16 PM  
**To:** Board (@caltrain.com)  
**Cc:** bikesonboard@sfbike.org; Nabong, Sarah; Murphy, Seamus; cacsecretary (@caltrain.com); Caltrain, Bac (@caltrain.com)  
**Subject:** More bikes on Caltrain

Caltrain Board,

I'm writing to ask that capacity be raised for bikes on all train types, including electrified service.

I'm a San Francisco home owner, voter, taxpayer and vocal citizen. I commute frequently (although at this time not daily) to the Peninsula. In the past I always took Caltrain, but these days I can't depend on getting on the train with my bike and the situation gets constantly worse. I would take Caltrain much more if I could always get on with a bike. Instead, I drive which is frustrating, slow and polluting. Bikes+trains are the better solution.

Biking is growing dramatically in the U.S. and around the world. This trend will only accelerate as electric bikes take hold. e-Bikes now account for 1 of every 3 bikes sold in Germany and there are \$5 billion in annual e-Bike sales in Europe. Millions of eBikes are sold annually in China. The U.S. is catching up and eBikes will bring millions of more people to bicycle commuting. This trend combined with improved bike infrastructure is likely to increase daily biking by 10-fold in the U.S. Caltrain needs to be a participant in this massive trend, not a laggard that failed to plan well.

On July 2, please vote to increase capacity to 20% on electrified trains. I'll be watching the vote carefully and will vote, donate and speak to my elected officials accordingly.

Thanks,  
Matt

--

**Matt Eggers**  
[matthewreggers@gmail.com](mailto:matthewreggers@gmail.com)  
San Francisco, CA

For solar, electric vehicle, demand response, and other cleantech news and opinions, follow me on twitter: @eggerrsmatt

## McKenna, Nancy

---

**From:** Aaron Verstraete <aaronv@gmail.com>  
**Sent:** Friday, June 26, 2015 11:33 AM  
**To:** Board (@caltrain.com)  
**Cc:** bikesonboard@sfbike.org; Nabong, Sarah; Murphy, Seamus; cacsecretary (@caltrain.com); Caltrain, Bac (@caltrain.com)  
**Subject:** Please increase bike capacity

Hello,

I love Caltrain & the services it provides. I live ~2.5 miles from Caltrain, however, so I have to find a way to get there. Muni takes almost 45 minutes for what I can do on my bike in 13 minutes. No brainer for me, right? (Same equation on the other end when I get to work). It is also a great way to squeeze in some active motion on an otherwise busy workday.

I am disappointed that the staff is recommending same bike capacity as today. Look at the trends we have seen in expanding of bike friendliness all over the Bay. Please reflect that in your commitment to bike capacity on our trains!

Hopefully you can see that this is such an easy choice to say yes to. Not only will cyclists appreciate it, but so will other riders who aren't troubled by frustrated cyclists being moved off the train because it is full

Kind regards,  
Aaron Verstraete  
Resident of San Francisco

## McKenna, Nancy

---

**From:** Don Harvey <harveydonw@juno.com>  
**Sent:** Friday, June 26, 2015 11:26 AM  
**To:** Board (@caltrain.com)  
**Cc:** bikesonboard@sfbike.org; Nabong, Sarah; Murphy, Seamus; cacsecretary (@caltrain.com); Caltrain, Bac (@caltrain.com)  
**Subject:** More bike space on electrified trains

Dear Board: Please provide more bike space on electrified trains--Don Harvey, 2039 Port Weybridge, Newport Beach, 949/759-9220

---

Old School Yearbook Pics

View Class Yearbooks Online Free. Search by School & Year. Look Now!

<http://thirdpartyoffers.juno.com/TGL3131/558d997bebb5d197b6c88st03duc>

## McKenna, Nancy

---

**From:** Carol Cook <cscook@stanford.edu>  
**Sent:** Friday, June 26, 2015 9:29 AM  
**To:** Board (@caltrain.com)  
**Cc:** bikesonboard@sfbike.org; Nabong, Sarah; Murphy, Seamus; cacsecretary (@caltrain.com); Caltrain, Bac (@caltrain.com)  
**Subject:** bike car capacity

Dear CalTrain,

One of the highlights of my work day is riding my bike from my home in Mtn View to the train station and being able to take my bike on the train so that I can ride up to my workplace upon arrival. This means that I don't have to deal with the expense and frustration of driving my car and I have a pleasant time enjoying being outside and interacting with other bicyclists while on the train. I have been doing this for over 10 years and very much appreciate that you folks at CalTrain allow bicycles on trains. Without this option it would be much more difficult to get to and from work and I wouldn't have the joy of having my bike be an integral part of my days commute.

The number of people bringing bikes on board has increased dramatically since the time I started bringing my bike on board. This is a good indication that people are willing to readjust their lives in order to have a positive impact on the environment and traffic congestion. Bike ridership will continue to increase from today until when the electric trains will be implemented in 2020. I am disappointed that CalTrain staff don't want to increase bike capacity on the future electric trains. Their position implies a dissolution of their partnership with bike riders for a less polluted and less congested urban area. I urge the CalTrain Board at its July 2<sup>nd</sup> meeting to overrule the recommendation and increase bike capacity to allow at least 16%, preferably 20% of passengers to bring bikes onboard electrified trains in 2020.

With great appreciation and sincerity,

*Carol Cook*  
*Sr. Financial Analyst*  
*Cost and Management Analysis, Stanford University*  
*Phone: 650-725-1752*

## McKenna, Nancy

---

**From:** Michael Pes <michael.pes@icloud.com>  
**Sent:** Friday, June 26, 2015 9:11 AM  
**To:** oard@caltrain.com; bikesonboard@sfbike.org; Nabong, Sarah; Murphy, Seamus; cacsecretary (@caltrain.com); Caltrain, Bac (@caltrain.com); Board (@caltrain.com)  
**Subject:** increase bike space on electrified trains

Dear Board members,

I ride my bike from Home to Caltrain and from Caltrain to office every day. This is a 10 miles ride that allows me to avoid adding to traffic congestion, occupying parking space, save on gas and help reducing CO2 emissions. I appreciate the possibility to bring my bike on board.

I was disappointed to read that Caltrain does not plan to increase bike capacity in the electrified trains and ask you to consider the benefits for the community of commuters not living close to train station but still opting for public transportation.

Thanks  
Michael Pes  
Redwood City



## McKenna, Nancy

---

**From:** Elizabeth Watson-Semmons <ewatson.semmons@gmail.com>  
**Sent:** Friday, June 26, 2015 7:32 AM  
**To:** Board (@caltrain.com)  
**Cc:** bikesonboard@sfbike.org; janice@sfbike.org; Nabong, Sarah; Murphy, Seamus; cacsecretary (@caltrain.com); Caltrain, Bac (@caltrain.com)  
**Subject:** I Support More Bike Space On Board and More Bike Parking for Caltrain

bicycles and caltrain are a natural blend there should never be a bicycle turned away for lack of space on a train please include ample space for bicycles in the plan for electric trains on the caltrain line Elizabeth Watson-Semmons

## McKenna, Nancy

---

**From:** Monica Lee <lee.monicaa@gmail.com>  
**Sent:** Thursday, June 25, 2015 10:38 PM  
**To:** Board (@caltrain.com)  
**Cc:** bikesonboard@sfbike.org; Nabong, Sarah; Murphy, Seamus; cacsecretary (@caltrain.com); Caltrain, Bac (@caltrain.com)  
**Subject:** Increase Bike Capacity on Electrified Trains

To Whom It May Concern,

As a bike commuter, I wanted to write ahead of the July 2 Board Meeting to please increase the bike space on electrified trains. Keeping the current space at 11% is far too little capacity for projected needs in the next decade.

Even at current capacity, I have been bumped multiple times, which has led to minor work crises. It's to the point where I've considered buying a car for my commute, because I need a reliable way to get to and from work on time. I work in public school and my job has very set work hours, so I really value having public transport I can count on. Biking is an important part of my commute - it saves a lot time and allows me to be in control of my commute schedule. Except for those occasions when I can't board Caltrain because bike capacity has been filled.

SF is full of people who are mindful of environmental impacts, as well as home to one of the most innovating electric bike companies (Faraday). I really hope the city will invest in these cleaner forms of transportation. **I ask that on July 2, you overrule the staff's recommendation and increase bike capacity to at least 16%, preferably 20%.**

Thank you,

Monica Lee  
San Francisco

## McKenna, Nancy

---

**From:** Lawrence <lawrencegarwin@yahoo.com>  
**Sent:** Thursday, June 25, 2015 10:33 PM  
**To:** Board (@caltrain.com)  
**Cc:** bikesonboard@sfbike.org; Nabong, Sarah; Murphy, Seamus; cacsecretary (@caltrain.com); Caltrain, Bac (@caltrain.com)  
**Subject:** Please INCREASE bike capacity on electrified trains coming in 2020.

Esteemed Caltrain Board Members,

I am contacting you to urge you to increase the capacity for passengers to bring their bicycles aboard the electrified train sets scheduled to arrive in 2020.

I frequently take my bike on the train to San Francisco, San Jose, and occasionally to points in between. Taking my bike allows me to get to my destination, often miles from the nearest Caltrain station, and sometimes any transit access, in a swift, healthy manner.

Eleven percent of Caltrain passengers bring bikes onboard today, and ridership projections show 20% will bring bikes onboard in 2020, but only if there is enough bike space. Bicycling is on the increase and should be encouraged. Biking to and from stations is cost-effective and biking doesn't cause pollution, traffic congestion, or take spaces in parking lots.

Additionally, Google is supporting a Silicon Valley initiative that may radically increase cycling. Given that their employees live all up and down the Caltrain corridor, we should even consider planning for Copenhagen-densities of bike riding and the associated increased Caltrain use.

And if you're concerned about not enough space for people without bikes, notice that when lots of passengers need to squeeze on trains, such as after ATT Park events, they stand and sit in the bicycle parking area, vastly increasing the train's capacity over them occupying seats.

Conversely, bumps of cyclists from peak hour trains are rampant and discourages bicycling and Caltrain use, making car driving more attractive. Despite your staff's suggestion to the contrary, bicycle capacity should be increased to 20%. If this is not possible, I understand 16% would be a vast improvement over the 11% staff is suggesting.

Thank you for your kind consideration in this matter.

Sincerely,

Lawrence Garwin  
Palo Alto

## McKenna, Nancy

---

**From:** Adele Madelo <adele.madelo@gmail.com>  
**Sent:** Thursday, June 25, 2015 10:27 PM  
**To:** Board (@caltrain.com)  
**Cc:** bikesonboard@sfbike.org; Nabong, Sarah; Murphy, Seamus; cacsecretary (@caltrain.com); Caltrain, Bac (@caltrain.com)  
**Subject:** Increase Caltrain bike capacity in 2020

Dear Caltrain Board Members:

It recently came to my attention that Caltrain staff has recommended maintaining the current bike capacity on its electrified service in 2020. While I live in Oakland, I have made trips to the Peninsula with my bike and appreciate that I can easily bring my bike on board. When I did, I found that I could easily maneuver between walk-on customers and the bike storage units. My sense is that I am one of many who experiences this. There are certainly regular bike commuters who ride Caltrain more frequently than I do, so I write requesting that Caltrain increase bike capacity to at least 16 percent on its new electrified trains. Doing so can meet demand and future growth.

With the growing number of bicyclists riding to the stations, the state can further save time and money with fewer parking spaces, traffic congestion, and improved public health. Based on a recent Caltrain passenger count, a significant number of bike passengers rode the trains compared to walk-on customers. It would make sense to further promote this trend through train design.

Thank you for your consideration. I look forward to taking Caltrain again to the Peninsula.

Sincerely,

Adele Madelo  
Oakland, California

## McKenna, Nancy

---

**From:** Virginia Smedberg <virgviolin@hotmail.com>  
**Sent:** Thursday, June 25, 2015 10:18 PM  
**To:** Board (@caltrain.com)  
**Cc:** bikesonboard@sfbike.org; Nabong, Sarah; Murphy, Seamus; cacsecretary (@caltrain.com); Caltrain, Bac (@caltrain.com)  
**Subject:** bikes on future Caltrains

Dear Members of the Board:

I am writing to request, earnestly, that at your meeting on 2 July, you overrule the staff recommendation about percentage of space for bikes (only 11%, which is the percentage of use NOW) and make the capacity the 20% that projections show WILL bring bikes onboard by 2020 - provided the bike space is there. Or get as close to that 20% as possible.

I don't understand why the staff thinks the needed bike capacity will be the same in 5 years - more and more people are getting on bikes.

When I travel by Caltrain I am usually going somewhere beyond the arrival station which I can get to by bike, and I live less than a mile from Calif Ave, so I love taking my bike. I don't have to worry about parking at either end, nor catching a city bus; I can read on the train (instead of sitting at the wheel of a car looking at other cars); I don't pollute; and I get my exercise! I prefer to take my own bike and have the things I need attached to it, rather than try to find one of the "loaner bikes" (but I am delighted those exist and I saw several people use them in San Francisco when I arrived on my opera trip - see below). I have been very happy that Caltrain has allowed me to do this, and I want everyone who even thinks of biking to have that option - we NEED fewer cars on our roads!

Last Tues when I went to the opera in San Francisco, all of us at Cal Ave managed to get on but at the next few stations bikers got refused because of lack of add'l space. I consider myself quite lucky, actually, not to have been refused in my years of Caltrain riding - esp when I was heading for a concert at San Jose State (waiting for the next train doesn't get you onto the stage in time to perform!)

Thank you for considering my comments.

Sincerely,  
Virginia Smedberg  
Palo Alto

**McKenna, Nancy**

---

**From:** Tessa Woodmansee <cleanairsj@gmail.com>  
**Sent:** Thursday, June 25, 2015 9:56 PM  
**To:** Board (@caltrain.com)  
**Cc:** bikesonboard@sfbike.org; janice@sfbike.org; Nabong, Sarah; Murphy, Seamus; cacsecretary (@caltrain.com); Caltrain, Bac (@caltrain.com)  
**Subject:** I Support More Bike Space On Board and More Bike Parking for Caltrain

Sent from my iPhone

## McKenna, Nancy

---

**From:** Sumanth Sukumar <sumanths@gmail.com>  
**Sent:** Thursday, June 25, 2015 9:31 PM  
**To:** Board (@caltrain.com)  
**Cc:** bikesonboard@sfbike.org; Nabong, Sarah; Murphy, Seamus; cacsecretary (@caltrain.com); Caltrain, Bac (@caltrain.com)  
**Subject:** Bike Capacity on electrified trains

Dear Caltrain Board,

While voting for the Bike capacity on the new electric trains, I'd like you to please consider my request to vote FOR increased capacity and AGAINST keeping the capacity at the current levels.

I currently use Caltrain to commute to work and bring my bike on board. This is because both my work and home are about 3 miles away from the nearest Caltrain station and I find that using a bike both provides a traffic free commute while also giving me health benefits.

Given the traffic congestion on bay area roads and California's stated goal to cut down climate warming greenhouse gas emissions, I am extremely surprised and dismayed at the Caltrain Staff's stance that fails to support environmentally beneficial and healthful option like biking.

My alternative to biking would be to drive to work or to Caltrain and park taking up limited parking spots and increasing congestion.

I'd like to ask you to please overrule the staff's recommendation and increase bike capacity to 20% of ridership and demonstrate leadership in meeting the stated goals of our State.

I live in Burlingame, CA

regards,  
Sumanth Sukumar

## McKenna, Nancy

---

**From:** snawbary@gmail.com  
**Sent:** Thursday, June 25, 2015 9:16 PM  
**To:** Board (@caltrain.com)  
**Cc:** bikesonboard@sfbike.org; janice@sfbike.org; Nabong, Sarah; Murphy, Seamus; cacsecretary (@caltrain.com); Caltrain, Bac (@caltrain.com)  
**Subject:** I Support More Bike Space On Board and More Bike Parking for Caltrain

Please consider the proposal to make room for 16% of passengers to bring a bike. It will reduce parking and traffic conflicts and move our society to a more modern and safe transit system.



## McKenna, Nancy

---

**From:** Zan Armstrong <zan.armstrong@gmail.com>  
**Sent:** Thursday, June 25, 2015 9:10 PM  
**To:** Board (@caltrain.com)  
**Cc:** Bikes on Board; Nabong, Sarah; Murphy, Seamus; cacsecretary (@caltrain.com); Caltrain, Bac (@caltrain.com)  
**Subject:** more bikes on board

Dear Caltrain,

On your July 2 meeting, please increase bike capacity to allow at least 16%, preferably 20% of passengers to bring bikes onboard electrified trains in 2020.

As traffic on 101 gets increasingly bad, it's an especially important time to have a viable public transportation option for getting between San Francisco and the south bay. Bikes make Caltrain possible for more people, by increasing the geographic range of people who can get to Caltrain. You shouldn't have to own a car to use public transit. But, if you have a bike, you need to know that you can board your train.

- Zan Armstrong, San Francisco

## McKenna, Nancy

---

**From:** Amanda Poon <amanda.m.poon@gmail.com>  
**Sent:** Thursday, June 25, 2015 8:02 PM  
**To:** Board (@caltrain.com)  
**Cc:** Nabong, Sarah; Murphy, Seamus; cacsecretary (@caltrain.com); Caltrain, Bac (@caltrain.com)  
**Subject:** Increase bike capacity on future trains.

Hello,

I am emailing regarding the issue of bike capacity on future Caltrain trains. I believe Caltrain needs to increase bicycle capacity, not keep the capacity static.

I live in San Mateo and take Caltrain 206 from Hillsdale to Menlo Park to get to work on weekdays. From August 2014-June 2015, I was bumped 4 times, all during my morning commute. In addition, I have been on many trains where bikes were turned away.

Please increase bicycle capacity on future trains.

Amanda Poon  
San Mateo, Hillsdale Station

## McKenna, Nancy

---

**From:** JJ Strahle <jj.strahle@gmail.com>  
**Sent:** Thursday, June 25, 2015 7:48 PM  
**To:** Board (@caltrain.com)  
**Cc:** bikesonboard@sfbike.org; Nabong, Sarah; Murphy, Seamus; cacsecretary (@caltrain.com); Caltrain, Bac (@caltrain.com)  
**Subject:** Increase Bike Capacity on Electrified Trains

Dear Caltrain Board,

I have lived in San Francisco for 15 years and worked anywhere from Redwood City to San Jose for 12 of those years. About 8 years ago, I discovered the joys of using a combination of bicycle and Caltrain when my car was in the shop. Since then, I have been able to commute using that method several times a week. It has helped to allow our family of four to get by with just one car, and provides me with a bit of exercise when I cycle for 3.5 to 6.5 miles on each end.

Unfortunately, since returning to work in Redwood City this past year, I have been bumped from the train on a few occasions. This results in panic and late fees when picking up my children from school or when trying to make performances or games. Therefore, I ask that you PLEASE INCREASE THE BICYCLE CAPACITY on the new trains being purchased for when electrification goes online.

I have personally witnessed an increase in bicycle/train commuting and see the trend as only increasing, as cities along the route improve their bike infrastructure, and more people move to the area.

Thanks for already allowing the service you do, but please increase the bike capacity planned for the new trains.

Thanks!

-JJ Strahls  
-San Francisco

## McKenna, Nancy

---

**From:** Jeff McKnight <jeff@mcknight.at>  
**Sent:** Thursday, June 25, 2015 7:21 PM  
**To:** Board (@caltrain.com)  
**Cc:** Caltrain, Bac (@caltrain.com); bikesonboard@sfbike.org; cacsecretary (@caltrain.com); Murphy, Seamus; Nabong, Sarah  
**Subject:** More bike capacity on electrified trains!

I've commuted with a bike on Caltrain for years, and very much you appreciate the service. However, I'm very disappointed that Caltrain staff is recommending no increase in bike capacity for electrified service in 2020.

Bike cars are already severely overcrowded during commute hours, so even if bike commuter levels stay at current levels, more bike capacity is definitely needed. And realistically, with the increases in bay area population and job market, bike ridership is likely to increase tremendously. Therefore, I strongly urge you to overrule the staff recommendation and increase bike capacity to allow at least 20% of passengers to bring bikes onboard electrified trains in 2020.

Thanks!  
Jeff McKnight  
Oakland, CA

## McKenna, Nancy

---

**From:** Smith, Cheryl <cheryl.smith@sap.com>  
**Sent:** Thursday, June 25, 2015 4:43 PM  
**To:** Board (@caltrain.com)  
**Cc:** bikesonboard@sfbike.org; janice@sfbike.org; Nabong, Sarah; Murphy, Seamus; cacsecretary (@caltrain.com); Caltrain, Bac (@caltrain.com)  
**Subject:** I Support More Bike Space On Board and More Bike Parking for Caltrain

Hi,

I live very near the San Antonio Caltrain stop. My bike and Caltrain are how I travel the majority of the time. Please increase the bike capacity as much as possible! Its crowded now and I want to see more people enjoy this healthy, easy transportation.

Thanks for all you do!

Best regards, Cheryl

### **Cheryl Smith**

Governance, Risk, and Compliance

3408 Hillview Avenue

Palo Alto, CA 94304

T: +1 650 687-4801

E: [cheryl.smith@sap.com](mailto:cheryl.smith@sap.com)

## McKenna, Nancy

---

**From:** Board (@caltrain.com)  
**Sent:** Thursday, June 25, 2015 2:42 PM  
**Subject:** Thank you for your comments

Thank you for contacting Caltrain with your comments on the new electric trains that will be procured as part of the Peninsula Corridor Electrification Project. We appreciate your feedback and interest.

As you know, the Board has not yet taken a policy action on the internal configuration of the new electric trains. Since late May, staff has been soliciting feedback about the new electric trains through a variety of venues including public meetings and electronic correspondence. Following this outreach effort, staff will make a final recommendation on the electric train configuration to the board at the July 2, 2015 meeting.

If you are interested in additional information about upcoming public meetings or copies of the presentations, please visit: [www.caltrain.com/emu](http://www.caltrain.com/emu)

Thank you for sharing your feedback.

Kind Regards,

Seamus Murphy, Caltrain Public Affairs Director

## McKenna, Nancy

---

**From:** Christian Wright <wrightchristian@yahoo.com>  
**Sent:** Thursday, June 25, 2015 2:03 PM  
**To:** Board (@caltrain.com)  
**Cc:** bikesonboard@sfbike.org; janice@sfbike.org; Nabong, Sarah; Murphy, Seamus; cacsecretary (@caltrain.com); Caltrain, Bac (@caltrain.com)  
**Subject:** I Support More Bike Space On Board and More Bike Parking for Caltrain

To the Board,

I urge the Caltrain Board to pass a design that provides bike capacity for at least 16 percent of Caltrain passengers

I support the transit agency making it an official goal that at least 20 percent of Caltrain passengers will access the system by bike by 2020 and I thank the Caltrain staff for recommending a significant \$3 million investment in secure bike parking and encourage the Board to approve this recommendation.

-CW

## McKenna, Nancy

---

**From:** Steven McGinnis <smcginnis@usa.com>  
**Sent:** Thursday, June 25, 2015 1:05 PM  
**To:** Board (@caltrain.com); Caltrain, Bac (@caltrain.com); Nabong, Sarah; Murphy, Seamus; cacsecretary (@caltrain.com)  
**Subject:** Please expand bicycle space on Caltrains

Please expand the capacity to carry bicycles on Caltrains. With global warming and news of another mass extinction event caused by CO2, it is important that we take steps to reduce our carbon footprint.

We are either part of the solution or part of the problem. Your children and grandchildren will inherit your decisions. Make the right one for them.

Steven McGinnis  
(925) 426-1290



## McKenna, Nancy

---

**From:** JB Christy <jbchristy614@gmail.com>  
**Sent:** Thursday, June 25, 2015 12:18 PM  
**To:** Board (@caltrain.com)  
**Cc:** bikesonboard@sfbike.org; janice@sfbike.org; Nabong, Sarah; Murphy, Seamus; cacsecretary (@caltrain.com); Caltrain, Bac (@caltrain.com)  
**Subject:** I Support More Bike Space On Board and More Bike Parking for Caltrain

Hello, CalTrain Board!

I understand that you will be meeting on July 2 to make pivotal decisions regarding the future of CalTrain. As a regular bike-train-bike commuter, I would like to add my voice to the thousands of Bay-area bikers represented by the San Francisco Bicycle Coalition. I urge you to make decisions that proactively encourage all Bay-area commuters to adopt this healthy, environmentally friendly and sustainable mode of travel. Specifically, I support SFBC's recommendations to:

- Set a transit agency goal that a minimum of 20% of passengers access Caltrain by bike by 2020;
- Provide bike capacity for at least 16% of Caltrain passengers, or approximately a 6:1 seat-to-bike space ratio;
- Ensure the most accessible platform and car design as possible for all passengers, including seniors, children, people with disabilities and people bringing bicycles onboard; and
- Allocate and invest appropriate resources, including funding, staff time and station space, to develop robust bike parking facilities and plan for the integration of the upcoming bike share expansion.

Thank you for your consideration of these recommendations. I realize you have far more priorities to weigh than I could hope to imagine. I appreciate your attention to making bike-train-bike trips safe, expedient and enjoyable for all.

-JB Christy

## McKenna, Nancy

---

**From:** Terra Conlon <terraconlon@gmail.com>  
**Sent:** Thursday, June 25, 2015 11:28 AM  
**To:** Board (@caltrain.com)  
**Cc:** bikesonboard@sfbike.org; janice@sfbike.org; Nabong, Sarah; Murphy, Seamus; cacsecretary (@caltrain.com); Caltrain, Bac (@caltrain.com)  
**Subject:** I Support More Bike Space On Board and More Bike Parking for Caltrain

Dear Caltrain,

I regularly use Caltrain to commute from San Francisco to various customer sites on the peninsula and San Jose. I support expanding the current bike space on Caltrain cars. The number of cyclists on the trains has risen sharply, but the space has not. Not only is getting room to place my bike on the bike car hard, but once I find a place for my bike, there is no place for me to sit.

It would be great if you only let cyclists on the bike car.

Thanks,  
Terra

## McKenna, Nancy

---

**From:** RA Pearsons <doggarden@mac.com>  
**Sent:** Thursday, June 25, 2015 11:26 AM  
**To:** bord@caltrain.com  
**Cc:** Nabong, Sarah; Murphy, Seamus; cacsecretary (@caltrain.com); Caltrain, Bac (@caltrain.com); bikesonboard@sfbike.org  
**Subject:** INCREASE BIKE CAPACITY ON ELECTRIFIED TRAINS

Caltrain Board

Please seriously consider increasing train capacity for cyclist, in particular cycling commuters.

Your own facts support the need.

Facts derived from Caltrain's February annual passenger counts:

- + Bikes-on-board passengers are Caltrain's fastest growing customer segment: bike boardings increased 147% from 2008 to 2014, while walk-on boardings increased only 35%.
- + Bicycle bumps increased 328% from 2014 to 2015.
- + In 2008, 6% of Caltrain passengers brought their bikes onboard. In 2014, 11% of Caltrain passengers brought their bikes onboard. At that growth rate (suppressed by bicycle bumps), 16% of passengers will bring their bikes onboard electrified trains.
- + Bicycle boardings increased 42% in October compared with February, whereas walk-on boardings increased only 11% (data from Caltrain's 2004 passenger counts, the only year Caltrain counted twice).
- + The average annual increase in bicycle boardings between 2008 and 2014 was over 17%, but the increase dropped to 5.7% in 2015 due to bicycle bumps. In contrast, the average annual increase for walk-on boardings was 5.5% between 2008 and 2014, but the increase jumped to 11% in 2015, even though some commute-period trains have standing room only.

As population growth continues to grow and our roads continue to be increasing and ridiculously overcrowded, we must adopt models for more efficient means of transporting people around the area.

Corporations such as Google are taking cycling commuters seriously.

My husband has commuted by bike for 30 years. Today, many of my neighbors have turned to bike commuting from my rural community of Danville. They may not use Caltrain but BART and they take their bikes for the other end of their commutes.

PLEASE help relieve congestion on our roads come 2020 and make the trains even more bike friendly. Plan for the future. Don't be blind to the obvious.

Thank you.

Ruth Ann Pearsons  
925-212-8074 [cell]  
[doggarden@mac.com](mailto:doggarden@mac.com)

## McKenna, Nancy

---

**From:** Matthias D. Kurzrock <mattkurzrock@gmail.com>  
**Sent:** Thursday, June 25, 2015 11:01 AM  
**To:** Board (@caltrain.com)  
**Cc:** bikesonboard@sfbike.org; Nabong, Sarah; Murphy, Seamus; cacsecretary (@caltrain.com); Caltrain, Bac (@caltrain.com)  
**Subject:** Capacities for self propelled passengers' vehicles.

Good day,

I greatly appreciate your personal Board services and the services of CalTrain.

Within your future planning please consider how to improve your potential & current passenger usage and satisfaction, our overall economy, our health, regional traffic flows, personal efficiencies, and the environment.

Increasing the bicycle & tricycle carrying capacity of all CalTrain units would be a positive towards accomplishment of all of the above. Self propulsion is increasing.

The demand is out there and growing. Google & others are expanding without providing additional automotive parking. Self propulsion is increasing.

A 20% increase in capacity would be both wise, justifiable and appropriate.

Increased functional capacity for both bicycles & tricycles will continue to feed the superlative percentage increase in bikes-onboard, especially when compared to the significantly lower walk-on percentage increases.

Continue to do your good work.

Do the right thing & do the thing right.

Anything worth doing is worth doing well.

Stay healthy and accident-free.

Semper Paratus - Semper Fidelis!

Matthias D. Kurzrock, DDS

◇ 925-465-4611; Facsimile, Fax: 925-465-4611

◇ Mobile: 925-330-4568

## McKenna, Nancy

---

**From:** boyziggy@gmail.com on behalf of Ziggy Tomcich <ziggy@sflasertag.com>  
**Sent:** Thursday, June 25, 2015 10:51 AM  
**To:** Board (@caltrain.com)  
**Cc:** bikesonboard@sfbike.org; janice@sfbike.org; Nabong, Sarah; Murphy, Seamus; cacsecretary (@caltrain.com); Caltrain, Bac (@caltrain.com)  
**Subject:** I Support More Bike Space On Board and More Bike Parking for Caltrain, and please keep the bathrooms.

Dear Caltrain board,

I ride caltrain frequently with my bike because there aren't any bike parking options at the Caltrain depot; who's bike parking closes too early for every trip I ever make. Everytime I ride caltrain from San Francisco to San Jose I need use the on board bathroom. It's a 90 minute ride off peak, and without any bike parking at caltrain Depot, how are cyclists expected to use the bathroom? We can't take our bikes into the bathroom with us nor can we lock our bikes anywhere near the bathrooms.

I urge you to please keep the bathrooms on board. The idea of removing on board bathrooms with 90 minute rides with is absolutely horrifying. It will add stress and anxiety to countless people's lives and will lead to accidents and on board messes.

While I always support more bike capacity, I do not support it if it means removing bathrooms. Please keep both.

Also if you had 24/7 secure bike parking that worked with bike link at all of your stations, I wouldn't need to take my bike on the train with me nearly as often.

Please expand bike parking at your stations, make it operate 24/7, and make it compatible with the bike link network Bart uses. People riding their bikes shouldn't need to enroll in multiple bike locker networks just to be able to lock their bicycle.

## McKenna, Nancy

---

**From:** Susie Osowski <susieosowski@gmail.com>  
**Sent:** Thursday, June 25, 2015 10:07 AM  
**To:** Board (@caltrain.com)  
**Cc:** bikesonboard@sfbike.org; janice@sfbike.org; Nabong, Sarah; Murphy, Seamus; cacsecretary (@caltrain.com); Caltrain, Bac (@caltrain.com)  
**Subject:** I Support More Bike Space On Board and More Bike Parking for Caltrain

Caltrain -

I regularly ride caltrain at least 4x a week to my place of work from SF to Lawrence Station. As part of my commute, I utilize my bike on each ends of my caltrain bike and always bring my bike with me. I am very fortunate that I tend to get on at stations where bike capacity is not limited. However, throughout my commute, I frequently see riders getting bumped bc there is not enough bike capacity on trains, ESPECIALLY during rush hours. I recognize that bike cars take up critical space on the trains, but if there was a chance that I couldn't take my bike on the caltrain, I wouldn't even consider taking Caltrain as part of my commute. Please consider that bikers are also doing their part to reduce congestion and improve air quality by biking and not driving to the stations and consider to the following points at your July 2 meeting.

- Set a transit agency goal that a minimum of 20% of passengers will access Caltrain by bike by 2020;
- Provide bike capacity for at least 16% of Caltrain passengers, or approximately a 6:1 seat-to-bike space ratio;
- Allocate and invest significant resources, including funding, staff time and station space, to develop robust bike parking facilities and plan for the integration of the upcoming bike share expansion;
- Ensure the most accessible platform and car design as possible for all passengers, including seniors, children, people with disabilities and people bringing bicycles onboard.

Thank You,

Susie Osowski  
Caltrain Rider & Biker since 2009.

## McKenna, Nancy

---

**From:** Bikes on Board <bikesonboard@sfbike.org>  
**Sent:** Wednesday, June 24, 2015 8:13 PM  
**To:** Board (@caltrain.com)  
**Cc:** cacsecretary (@caltrain.com); Caltrain, Bac (@caltrain.com)  
**Subject:** Caltrain electrified car design needs improvement

Dear Joint Powers Board,

We would like to draw your attention to an article published in the San Mateo Daily Journal today.

Sincerely,  
BIKES ONboard team  
San Francisco Bicycle Coalition  
[www.sfbike.org/bob](http://www.sfbike.org/bob)

<http://www.smdailyjournal.com/articles/opinions/2015-06-24/op-ed-caltrain-electrified-car-design-needs-improvement/1776425145558.html>

### **OP-ED: Caltrain electrified car design needs improvement**

*By Shirley Johnson*

On July 2, Caltrain's Joint Powers Board will make a decision that will affect the rail line for decades — the board will vote on the design of new electrified rail cars. It is alarming that Caltrain staff is recommending an inadequate car design, which doesn't meet today's needs, much less those of the future. Hopefully, the board will overrule staff and vote for a more sensible design.

Caltrain plans to electrify its line in 2020 to replace its aging diesel fleet with new electrically-powered rail cars. Electrified trains will accelerate and decelerate faster, enabling shorter travel times and more trains per hour, and will also be quieter and cleaner than diesel trains.

Electrification is an opportunity for Caltrain to design a train system from the ground up to meet the needs of all passengers. The most important thing is to increase overall capacity, so that more passengers can comfortably ride Caltrain. Growth in Caltrain ridership is expected to accelerate through transit-oriented development and increased population. Caltrain must plan to accommodate this increased ridership through longer trains with thoughtfully designed rail cars that meet future passengers' needs.

However, Caltrain staff's recommendation for car design is deficient in two main ways: staff is recommending no bathrooms and no increase in bike capacity. A bathroom is an important amenity for joyful Giants fans and Friday afternoon party cars, and space for more bikes onboard is already needed.

Historical increases in Caltrain bike boardings have significantly outpaced walk-on boardings. From 2008 to 2014, the average annual increase for bike boardings was 17.1 percent compared with only 5.5 percent for walk-on boardings.

Bike cars are maxed out and the increase in bike boardings plunged by two-thirds in 2015, while the increase in walk-on boardings doubled. Even when trains have empty seats, full bike cars result in customers with bicycles

left behind on the platform with paid tickets in hand. Bicycle bumps increased over three-fold in the last year alone. With the rapid increase in bicycling in the Bay Area, it's unthinkable not to plan for more bike capacity in 2020, when customers with bicycles are already being underserved today.

According to a Caltrain passenger survey, 80 percent of people who bring bikes onboard said they rarely if ever ride Caltrain without their bikes, and the slowdown in bike boardings this year proves it. Full bike cars pushed people off the train and back into their cars contributing to traffic congestion, pollution and fossil fuel consumption.

Bay Area roads are increasingly congested, costing workers lost time and more stress as they commute on clogged freeways. Furthermore, pollution from automobiles is the single largest contributor of greenhouse gas emissions in the Bay Area. Bikes onboard Caltrain mean fewer cars on our roads and cleaner air for us all to breathe.

Caltrain predicts that overfilled parking lots during the electrification era will result in lost ridership. Adding bike capacity to electrified trains would curb that loss, because bikes onboard free up parking spaces at stations and on nearby surface streets. Those who need to drive will be able to find parking spaces more easily.

Economic analysis shows that Caltrain's bikes onboard service saves the transit system money, because passengers who bring bikes onboard do not use heavily subsidized shuttles, feeder buses or parking lots. Only walking to and/or from stations is more cost-effective than bringing a bike onboard the train, but most people live and work too far to walk. More bike capacity on new rail cars is an outstanding way for Caltrain to save taxpayers money and enable more people to access stations in an environmentally friendly way.

Ridership trends demonstrate that at least 20 percent of Caltrain passengers will bring a bike onboard in 2020, given adequate bike capacity. Yet staff is recommending no increase over today's bike capacity. We'll be saddled with these cars for decades, so it's extremely important to design them with the future in mind. We look to the board to override staff's recommendation and accommodate the upward trend in bicycling by voting to increase bike capacity on electrified trains.

The board meeting is 10 a.m. Thursday, July 2 at 1250 San Carlos Ave., San Carlos. The public is invited to attend.

Shirley Johnson, Ph.D., leads the BIKES ONboard project sponsored by the San Francisco Bicycle Coalition, and was awarded SFBC's Golden Wheel in 2014. She is former chair of the Caltrain Bicycle Advisory Committee and current vice-chair of the BART Bicycle Advisory Task Force.