

E-locker Update

Bicycle & Active
Transportation Advisory
Committee

September 21, 2023



E-lockers & Biking in the Corridor

- 324 spaces at 22 stations
- 21% of Caltrain customers use a bike as part of their trip*
 - Most take it on board (19% of all customers)
 - The rest (2% of all customers) leave a bike at a station
- *2022 Customer Satisfaction Survey of over 2,000 people



Zone 1



Zone 2



Zone 3



Zone 4



Overall Use - Unique Cards

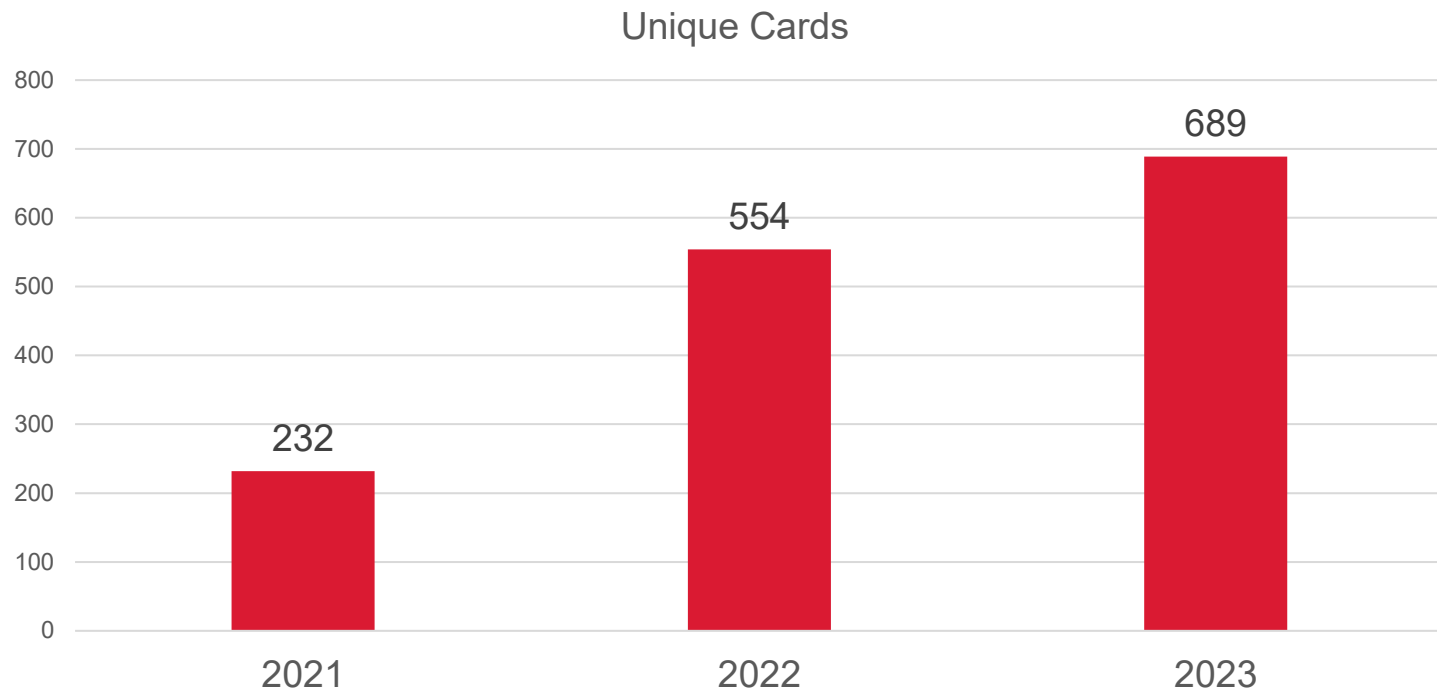

- Compares mid-June to mid-September in each year

Overall Use – Weekday Rentals

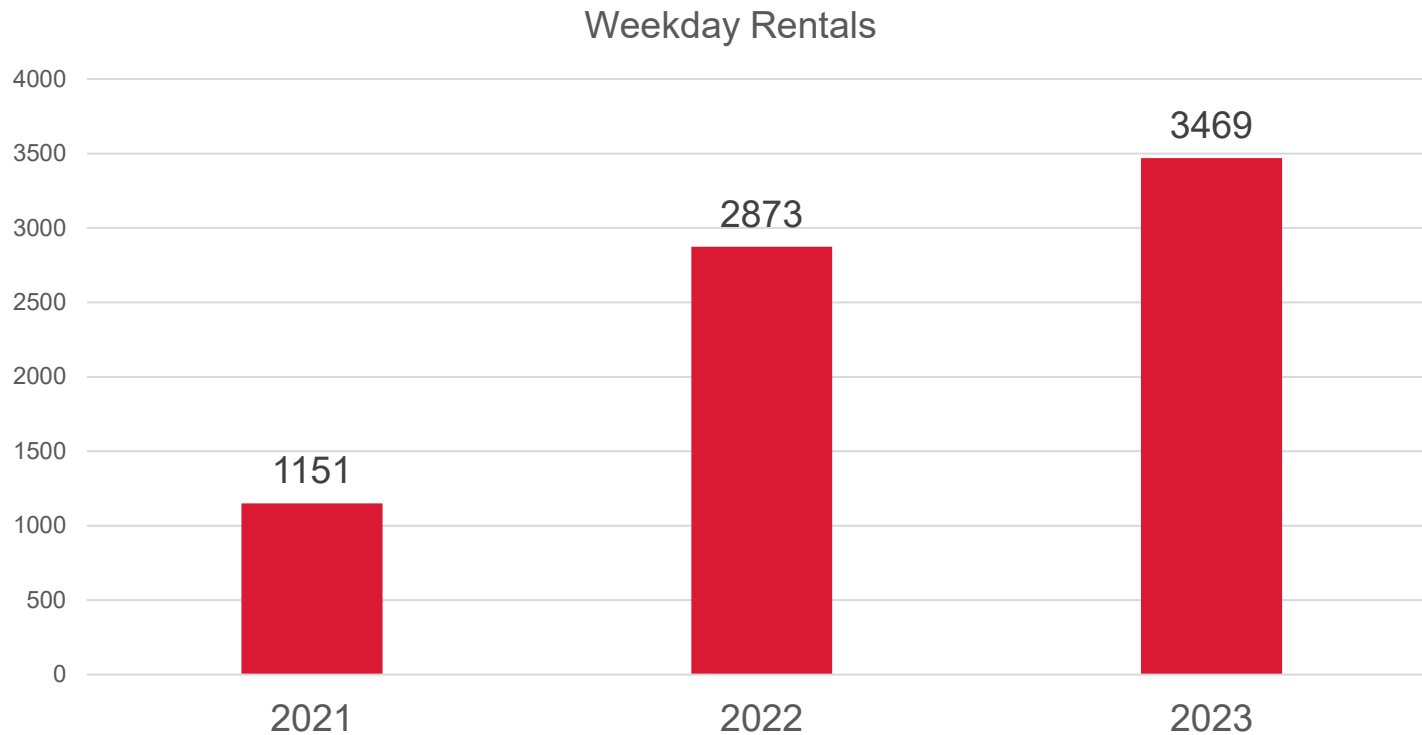

- Compares mid-June to mid-September in each year

Overall Use – Weekend Rentals

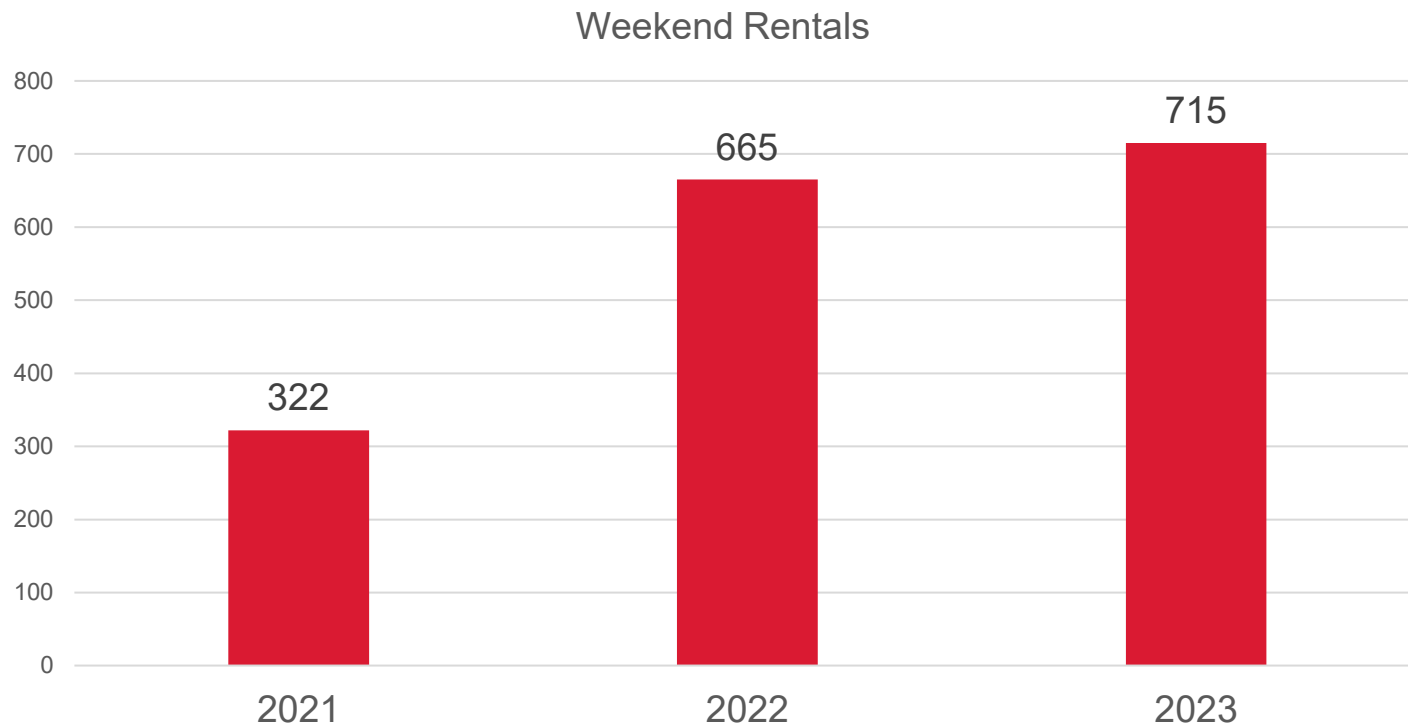

- Compares mid-June to mid-September in each year

Overall Use – Total Rentals

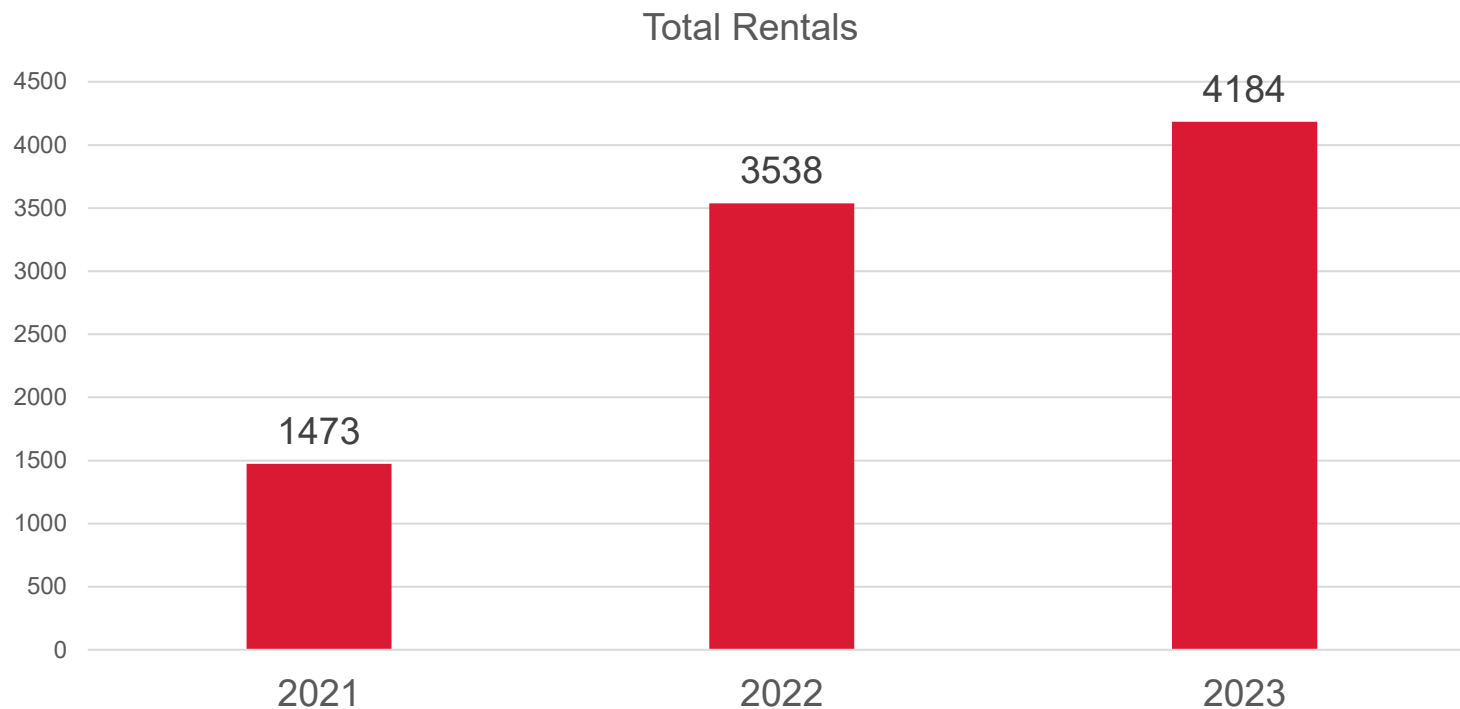

- Compares mid-June to mid-September in each year

Customers by Station

Unique Access Methods

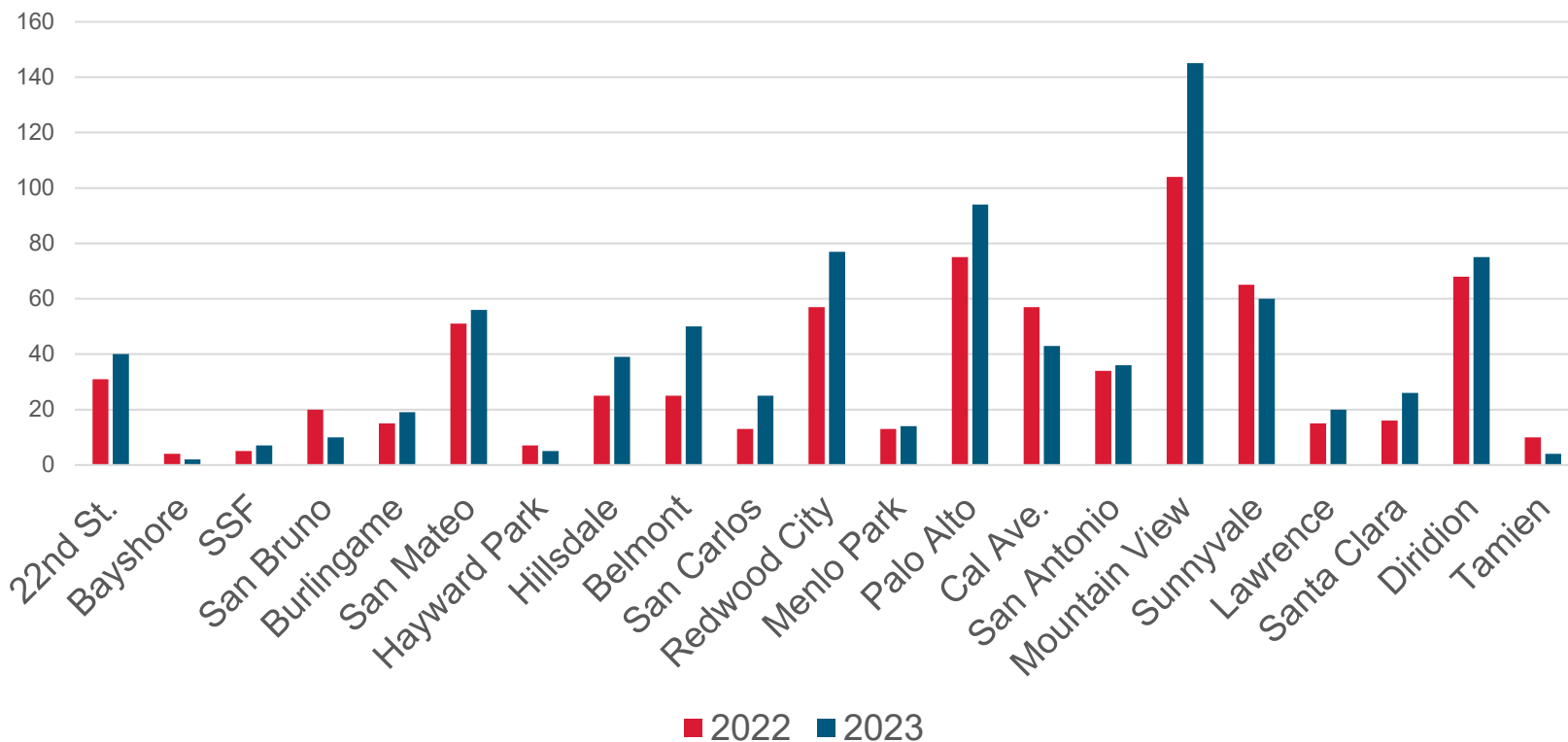

- Mid-June to mid-September
- Millbrae data not available
- Biggest increases: Mountain View, Belmont, Redwood City

Total Rentals by Station

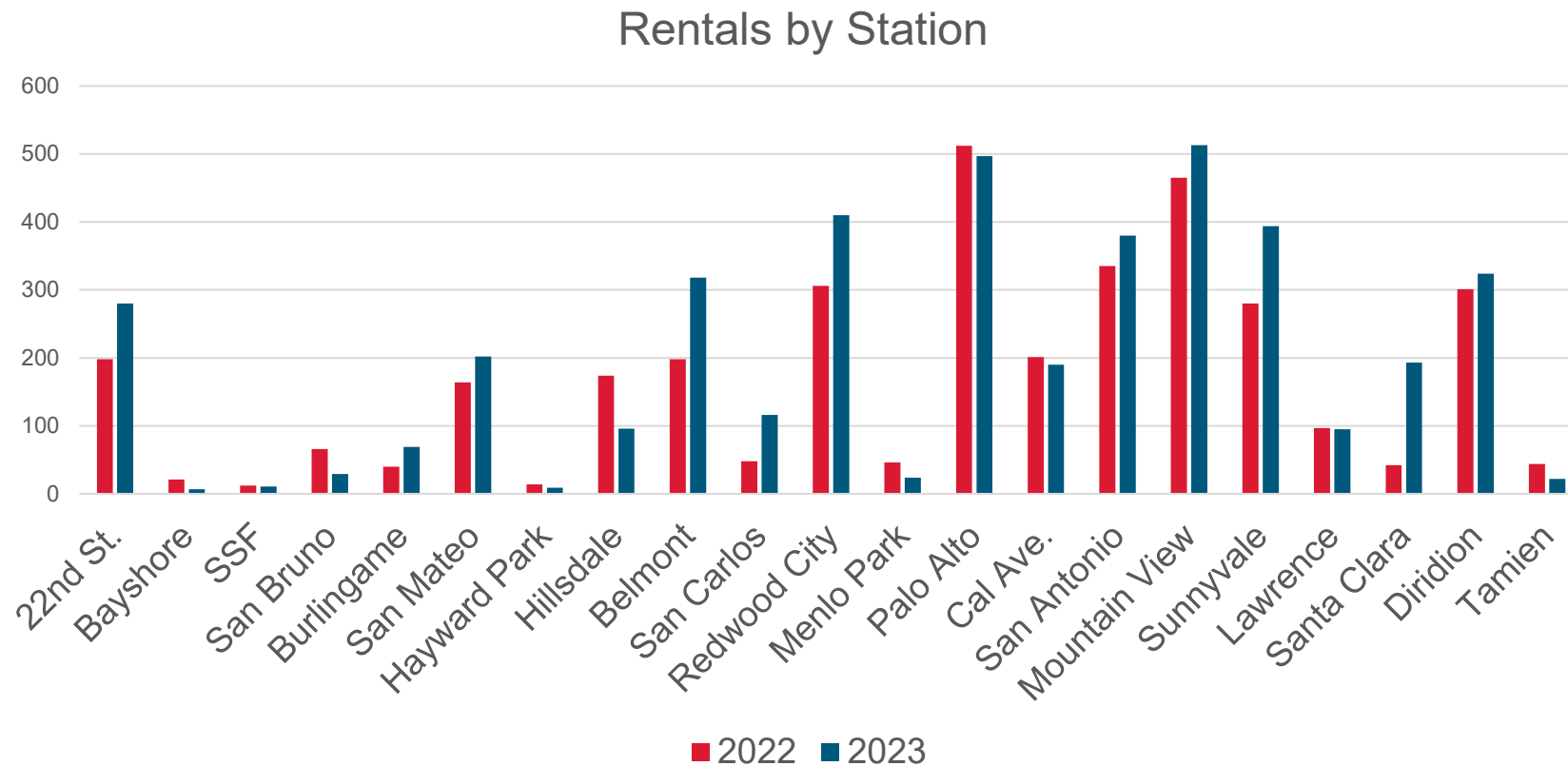

- Mid-June to mid-September
- Millbrae data not available
- Biggest increase: Santa Clara, Belmont, Sunnyvale

Overall Use

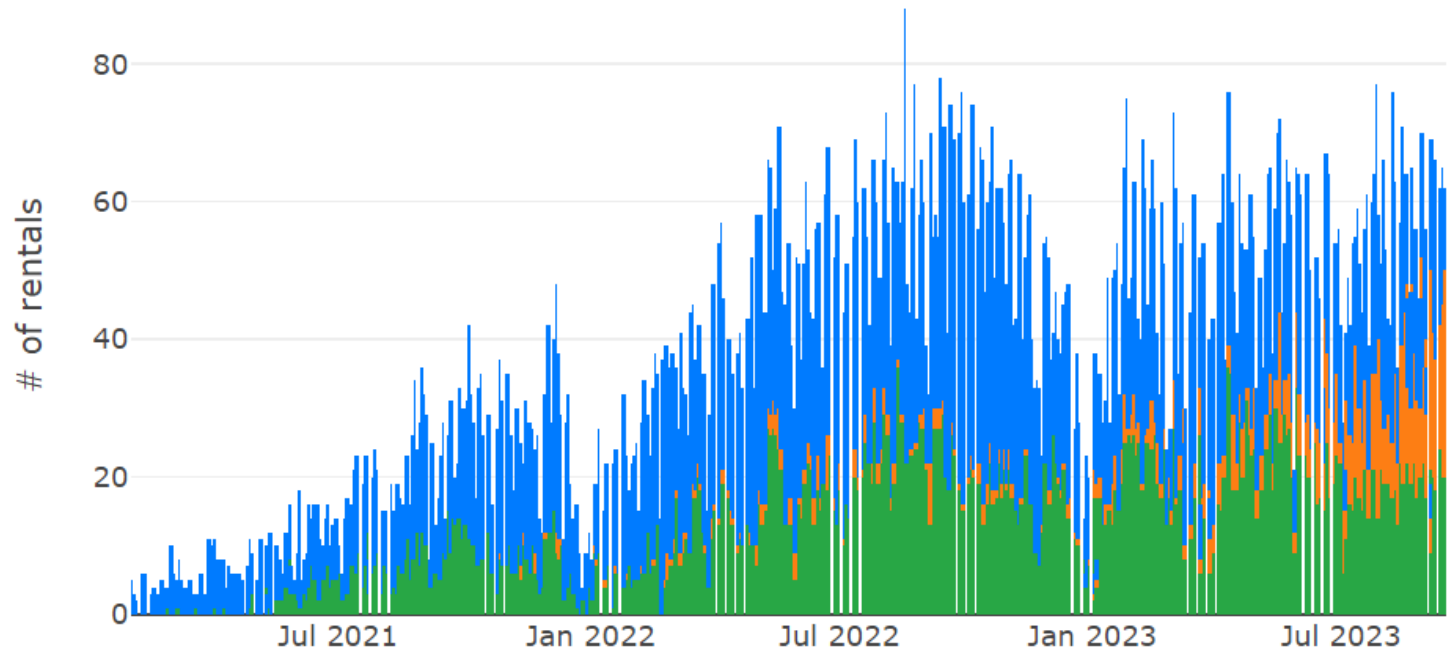

App Clipper Bike Link Card

- 29,455 rentals started
- 2,192 unique cards

Contract Modification

- Costs of sheet metal increased significantly
 - Vendor costs were up 40+%
 - We decided to wait and see
 - Costs have come down
- Working to revise contract
 - New price list anticipated this week
 - Includes G7 lockers
 - Added security
 - Cargo bike layout
 - 2nd level possible

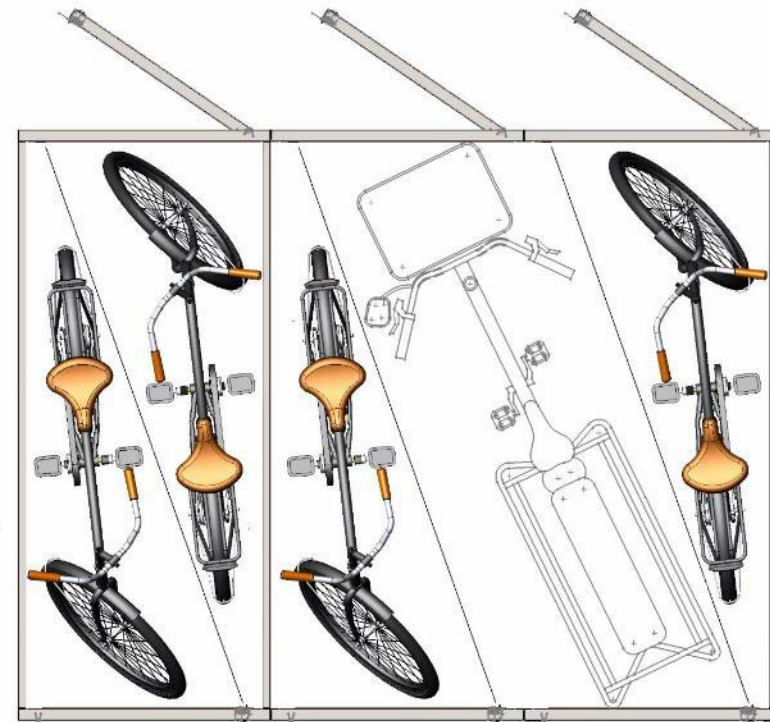

Bike Link App



- App is available
- QR stickers on lockers
- A-frame info signs being prepared
- New video:
<https://www.youtube.com/watch?v=mMVfFceWo3k>

Questions

